

siteco

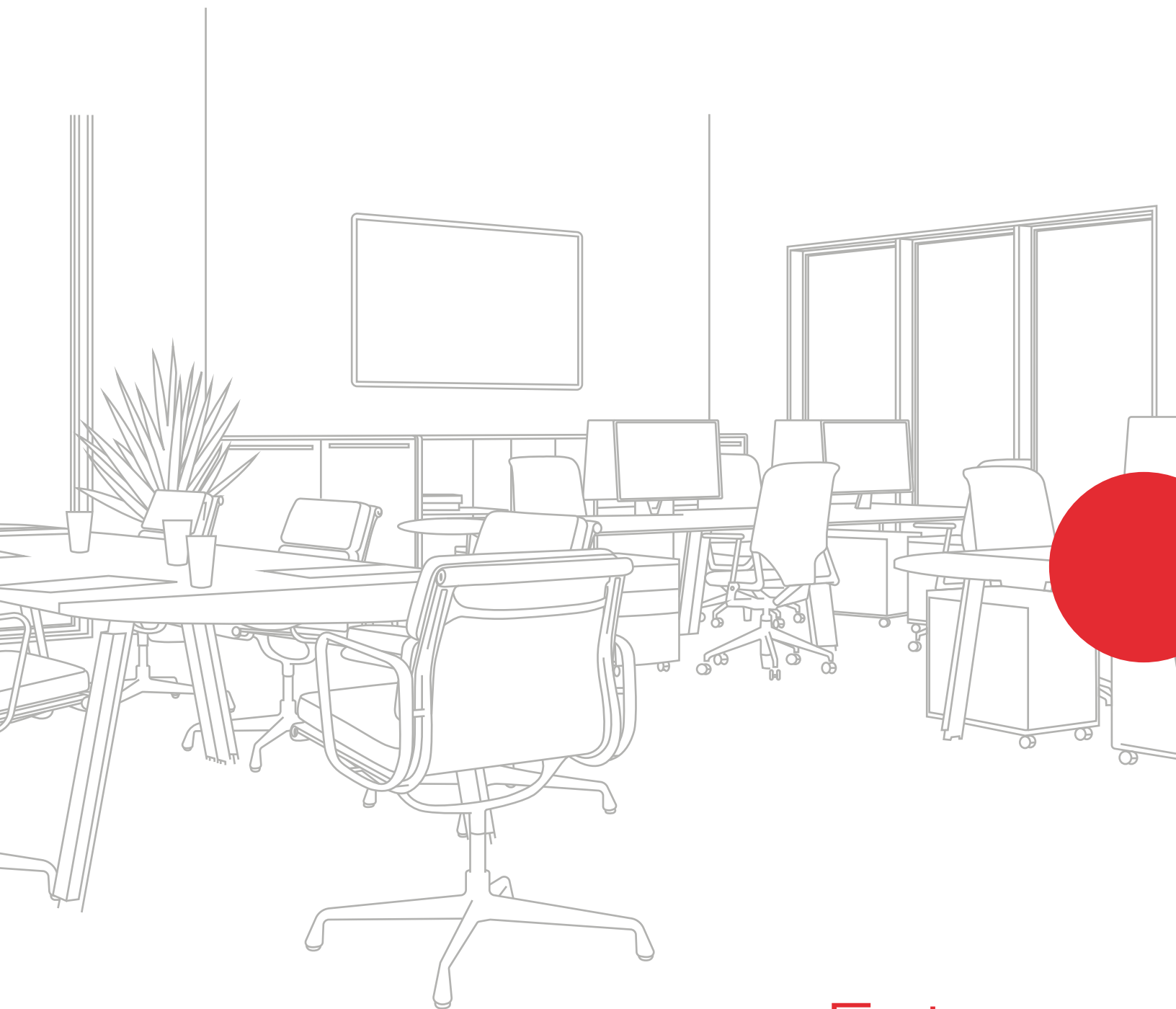

Future Office.

We take responsibility for your light –
lighting technology designed and engineered in Germany.

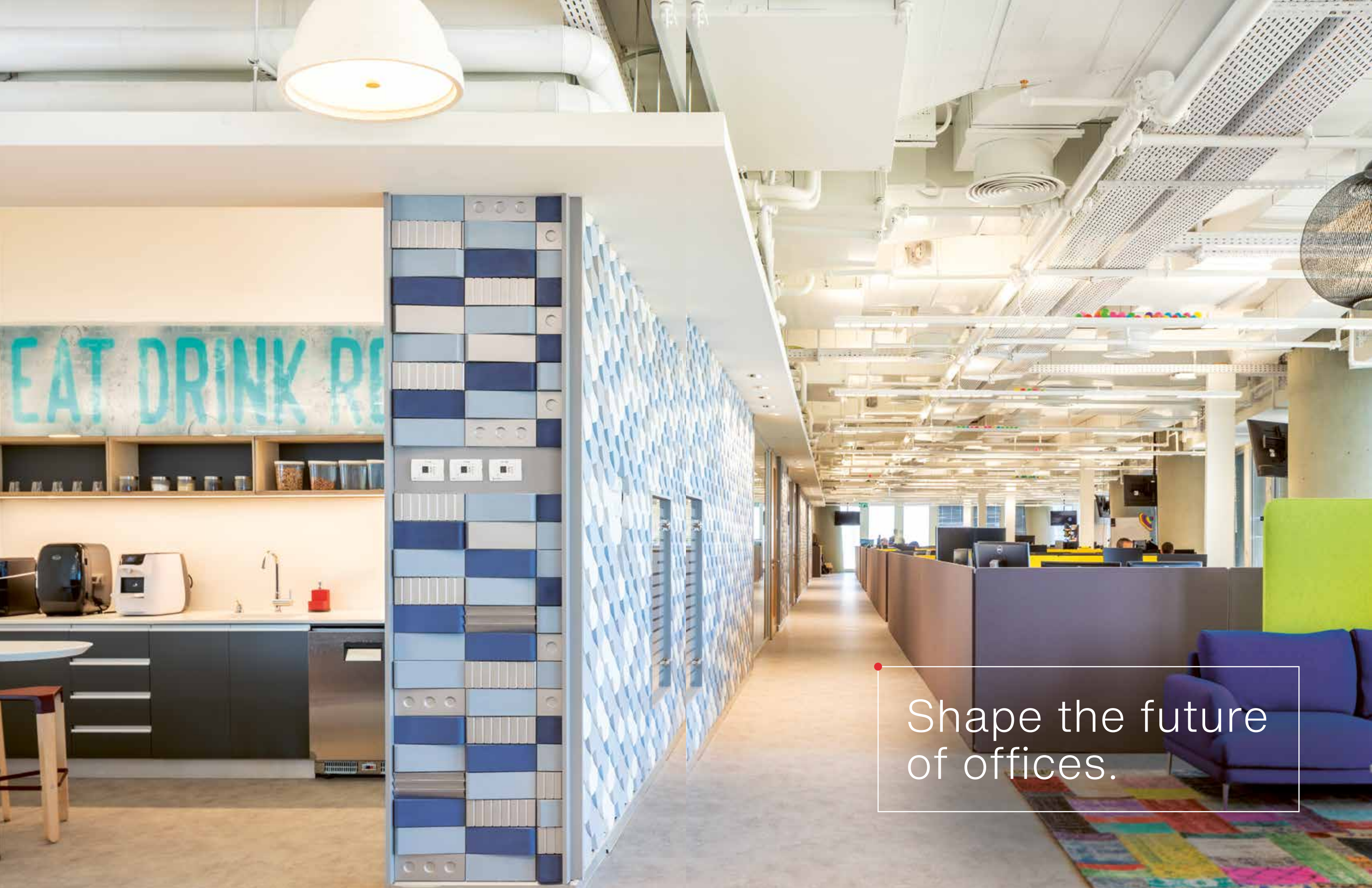

Shape the future
of offices.



Quality of life

Flexibility
Sustainability

Office – or: the place where work and life merge.

More flexible, agile and spontaneous – the offices of tomorrow are a dynamic hub for transferring information and knowledge. Which is why contemporary room concepts focus on people as the knowledge bearers and key players. An elementary component of such concepts: the right lighting. Light for people. It sounds simple, but requires a lot of know-how. Because light must enable concentrated work and at the same time create a pleasant atmosphere.

SITECO stands for best light.



Bright daylight moves
across the office.

Be inside and feel outside.

Light influences our body – visually, emotionally and biologically. The course of natural daylight is the pulsing mechanism for our inner clock. At the same time, we spend over 90 % of our time in closed buildings. With color temperature, illuminance and light dynamics, well-being and performance can be significantly increased.

Technology is only the basis for this. Planning, configuration, installation and programming must be perfectly matched to the individual conditions. We've developed an approach that takes into account all relevant factors for maximum effect: SITECO HCL^{live}.

For the OMNITURM project SITECO demonstrated its full expertise with customized ceiling luminaires.

HCL^{live} implemented in real life.



1 + 2

Project: OMNITURM, Frankfurt, Germany

Product: Scriptus® (customized)

Experiencing the value of outstanding optics and lighting technology.

Modern working also means continuously switching between work with display screens, printed texts and beamer presentations – meaning constant stress for the eyes. High quality light counteracts this and protects the eyes from fatigue.

Not only do our solutions meet industry standards; they also offer peak photometric values for maximum visual comfort and comfortable working. SITECO lighting technologies, such as its primary lens cluster and patented Micro Lens Array, generate light with outstanding uniformity, color rendering and maximum glare control.

Innovative optics and lighting technology paired with HCL^{live} are a boon for stressed eyes. The employees of Munich's Fluxunit learned that first-hand.

Perfectly adapted light creates pleasant visual comfort throughout the complete office.





With our HCL^{live} configurator, together we make complexity manageable and the solution tangible.

We know which questions to ask: from workplaces according to normative standards to individual spatial conditions.

The result: precise parameters for optimized control of color temperature, illuminance and light dynamics.

For us, human centric lighting is more than just a definition.

On paper, anyone can do HCL nowadays. We transform it into reality. HCL^{live} is our promise to achieve the greatest benefit from HCL in your specific situation. During the process we support and accompany you, from holistic planning, installation and commissioning to fine tuning.

SITECO HCL^{live} is a new dimension of light.



Quality of life

Flexibility

Sustainability

Light – as flexible as modern work concepts.

The world of work in tomorrow's offices is flexible and digital. This also applies to the light. Create the right environment now for new work concepts using intelligent lighting solutions.

The decisive factor for sustainability of the lighting: maximum adaptability and availability of open interfaces for networking requirements. We offer future-capable lighting solutions through maximum application flexibility and smart networking options.

**SITECO stands for intelligent
lighting solutions.**



From us to you: the right light for the whole office.

Office buildings contain more than just desks and meeting rooms. They also have striking foyers, attractive communication zones and functional maintenance and utility rooms.

Our comprehensive portfolio offers maximum flexibility for the best possible lighting and an attractive office concept. You decide between an uniform appearance using ideally aligned range concepts or individual customizing solutions.

That means complete freedom with interior layout. As implemented by the streaming provider Joyn:

“Our SITECO lighting solution gives us the design flexibility we need.”

The real added value of digitization.

Integration of the DALI control standard, sensor technology and digital interfaces are our responses to the lighting of tomorrow's offices. Our solutions ensure flexibility through maximum compatibility and maximum adaptability. This opens up a wide spectrum of networking and control options, ranging from adaptive lighting via presence detection to integration into high level building management systems. The ideal prerequisites for intelligent space management.

The Marinaforum in Regensburg, Germany, showcases various lighting scenes made possible through intelligent control integrated into the building management system.

A historical room in new splendor,
equipped to be used flexibly
and sustainably.

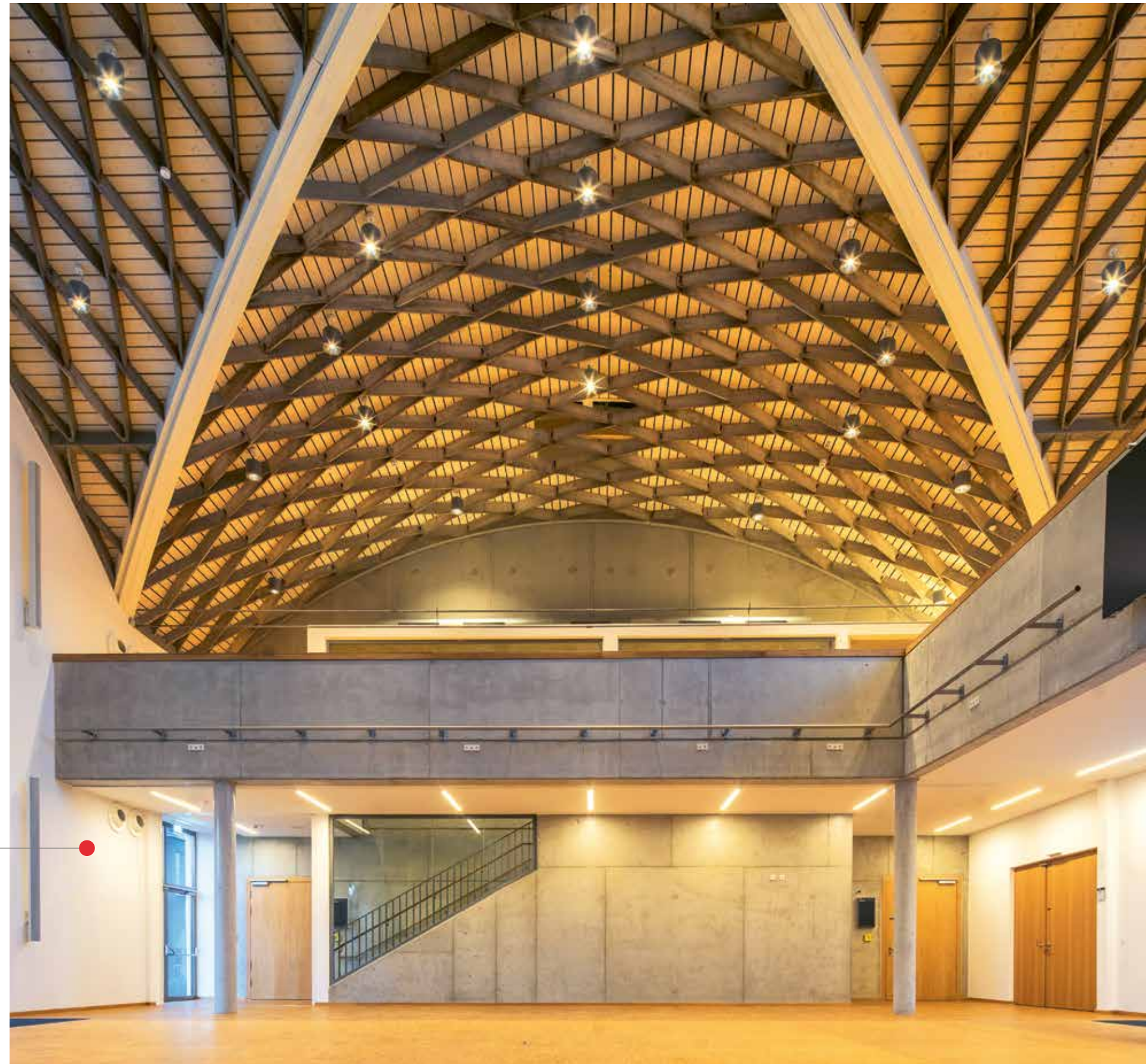

Not open for debate: Everything must be possible.

Now or later. We create the infrastructure that leaves all your options open. From the simple plug-and-play control to the fully integrated building management system – SITECO Connect delivers tailor-made solutions. And we accompany you through the entire process: Planning, programming and commissioning.

SITECO Connect for next-level digital solutions.

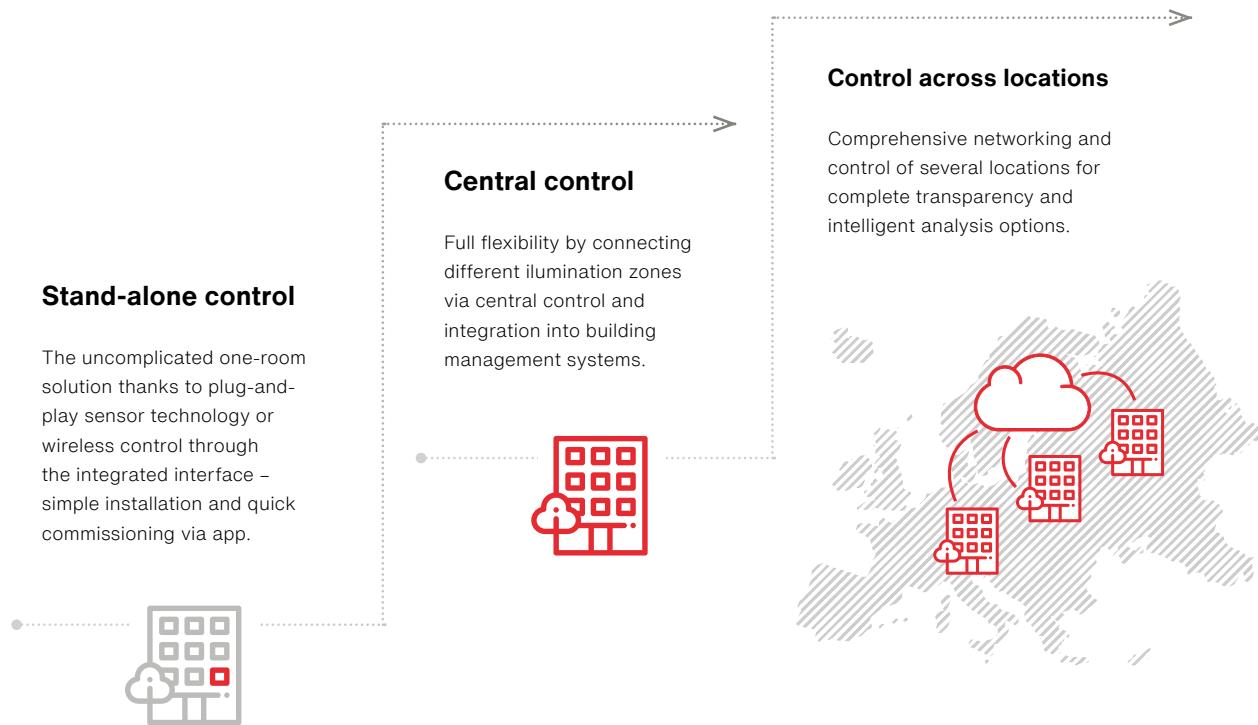

“Today we control locally, but soon across multiple locations.”

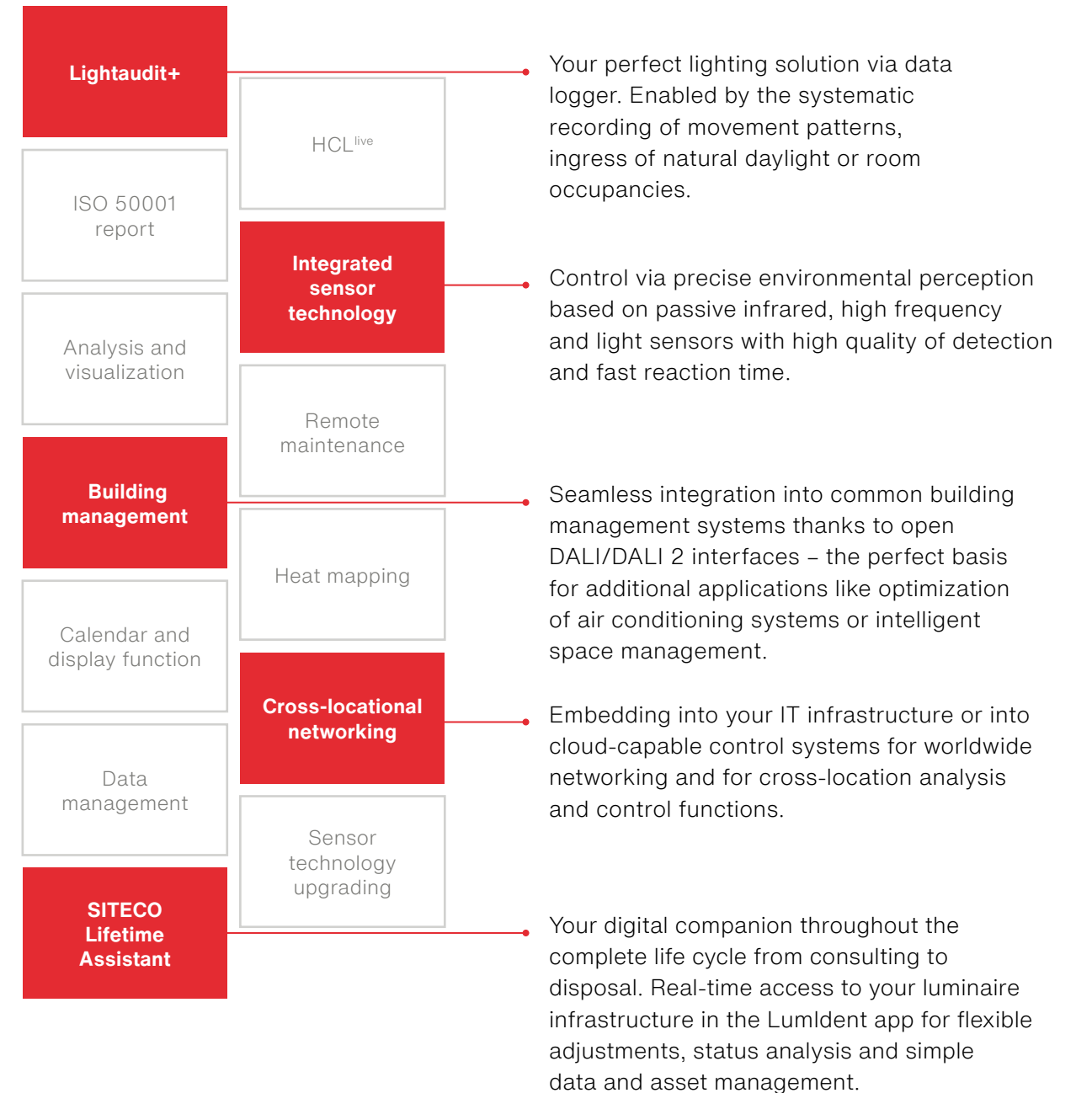



Quality of life
Flexibility

Sustainability

Planning, construction, operation – modern office buildings demand holistic concepts for sustainability.

One of the most important factors: energy consumption during use. This is where the CO₂ balance and economic efficiency of the building operation are determined. Lighting is a key driver, even today generating a large proportion of building energy costs. State of the art lighting technology sets new standards for greater energy efficiency and lower operating overheads.

SITECO stands for sustainable lighting solutions.

Invest, optimize – and save money at the same time.

Swap old for new: the quickest way to achieve more efficiency in existing buildings is to replace conventional lighting. SITECO offers suitable LED solutions with standard dimensions and diverse mounting options for minimal refurbishment efforts. To make sure the savings effect is immediately noticeable, our luminaires feature up to 200 lm/W and state of the art sensor technology for lighting according to your specific needs. Technical features such as advanced CLOi luminous flux tracking prevent energy waste through excess-planning – our contribution to energy savings of up to 80 % and extremely short payback times.

Renovation is worthwhile. De Winder architects went one step further, transforming an old factory building into modern office worlds for Mozilla in Berlin:

“Whether renovation or complete refurbishment – SITECO lighting enables economical and aesthetically pleasing solutions.”

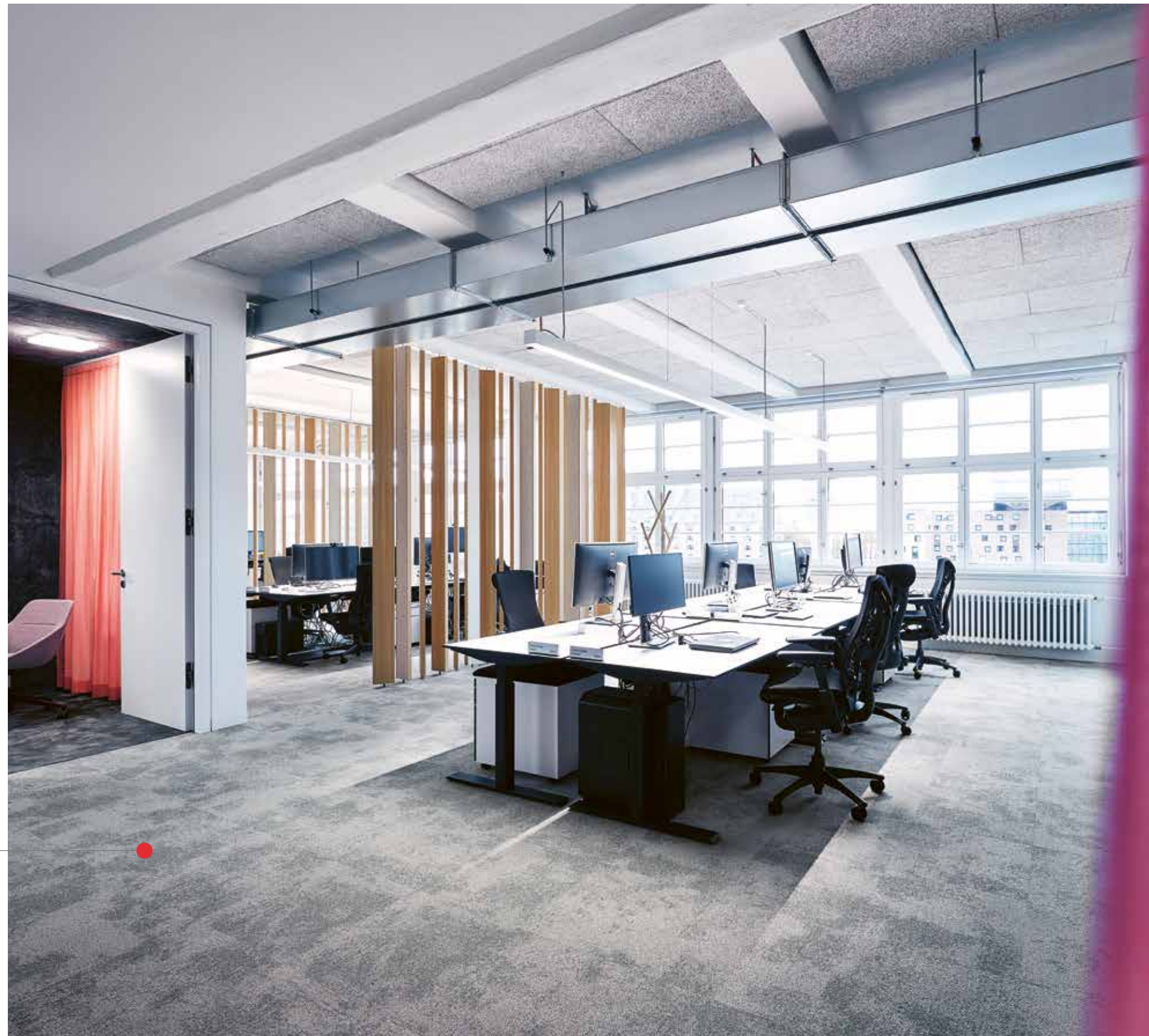

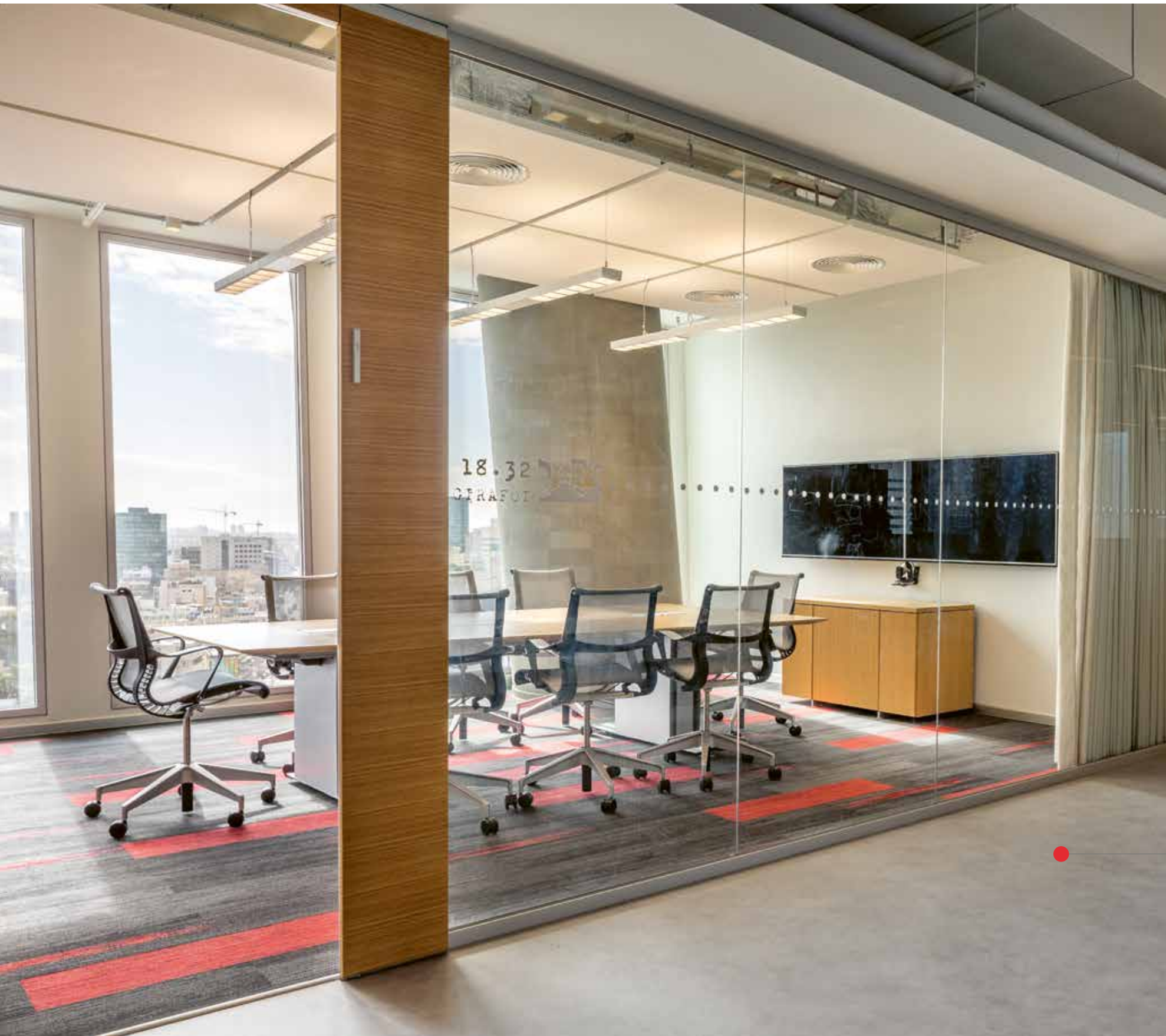

Our promise for minimum operating costs.

LED solutions enable energy-efficient and cost-efficient building operation, and well thought-out product concepts guarantee it stays that way for a long time. The durability of our luminaires with up to 100,000 hours of service life makes investments plannable. At the same time, modular designs ensure easy maintenance and upgradeability. Zero tolerance regarding downtimes is also a matter of course for us and your guarantee for low total cost of ownership (TCO).

We were able to convince our Tel Aviv-based customer West Pharma of our performance and quality promise.

Significantly lower maintenance
thanks to SITECO lighting.

If not now, then when.

Our specialists show you what's possible by analysing the specific conditions at your site.

Hand in hand with architects, lighting designers and electrical contractors, we translate your functional and design requirements into your ideal technical solutions – made tangible using state of the art visualization.

SITECO enables all scales, from pilot projects to a big step.

The SITECO audit provides complete transparency about the energy consumption and CO₂ emissions of your existing system.

Our lighting consultants design a solution that is based on your requirements and tailored to your needs.

The result: Clarity on your cost and energy savings potential – and completely clear thanks to our detailed TCO comparison calculation.

Total cost of ownership (TCO) comparative calculation for payback period

■ Apollon®
● 4 x 18 W T8

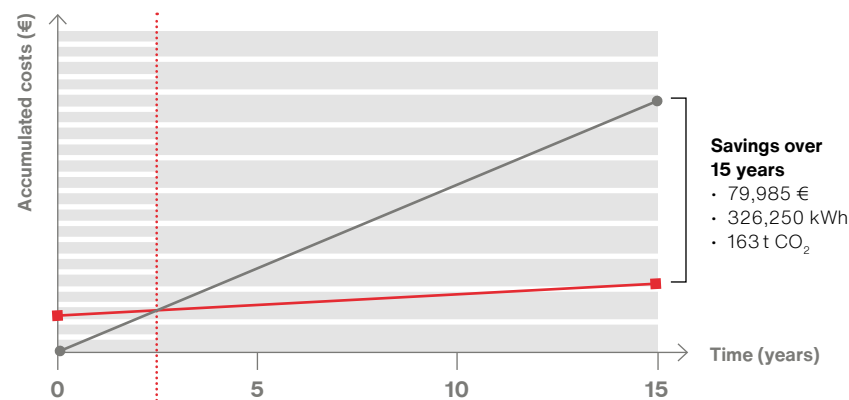

New Apollon® system amortized in **2.4 years**

	Existing system	SITECO solution	SITECO
Luminaire type	4x18W T8	Apollon	Reference L70
System configuration			
Luminaire rated power [W]	72	38	
Illuminance Em [lx] / MF	500	700	
Energy consumption			
Energy consumption / year [kWh]	36,000	14,250	
Energy consumption / system service life [kWh]	540,000	213,750	382,250
Energy consumption savings [%]	0	60%	
Investment costs			
Investment costs [€]	5,600	20,700	
Energy costs			
Energy costs per year [€]	6,120	2,423	
Energy costs over system service life [€]	91,800	36,338	
Energy costs saved in %	0%	60%	
Maintenance costs			
Maintenance costs per year [€]	2,880	239	
Maintenance costs over system service life [€]	43,200	3,578	
Maintenance cost savings	0%	92%	
Total Costs of Ownership (investment costs + energy costs + maintenance costs)			
Total costs over system service life [€]	140,600	60,615	79,985
Total cost saving	0%	57%	
Payback time in years	0	2.38	
CO ₂ saving per year [t]	0	11	
CO ₂ saving over system service life [t]	0	163	

TCO Calculator is an application of Siteco GmbH - Germany © Siteco GmbH 2020



Lighting technology

We admit it,
we love lighting
technology.

SITECO is a technology pioneer with more than 150 years of experience. CLO 2.0, full cut-off, freeform reflector technology with a globally unique silver coating process. We stand for more than 200 patented lighting technologies with diverse application options for you and your future. We also offer you holistic luminaire development from a single source – from the optics, mechanics and thermal design right up to the control electronics. The perfect integration of hardware and software designed and engineered in Germany.

**SITECO stands for exceptional
lighting technology.**

For us, optics is more than simply guiding light.

Optical systems have always been our strength – the Scriptus® for example features a unique combination of primary lens cluster, blending chamber and patented Micro Lens Array.

SITECO optical technology stands for maximum uniformity of illuminance, ideal contrast rendering and perfect glare control.

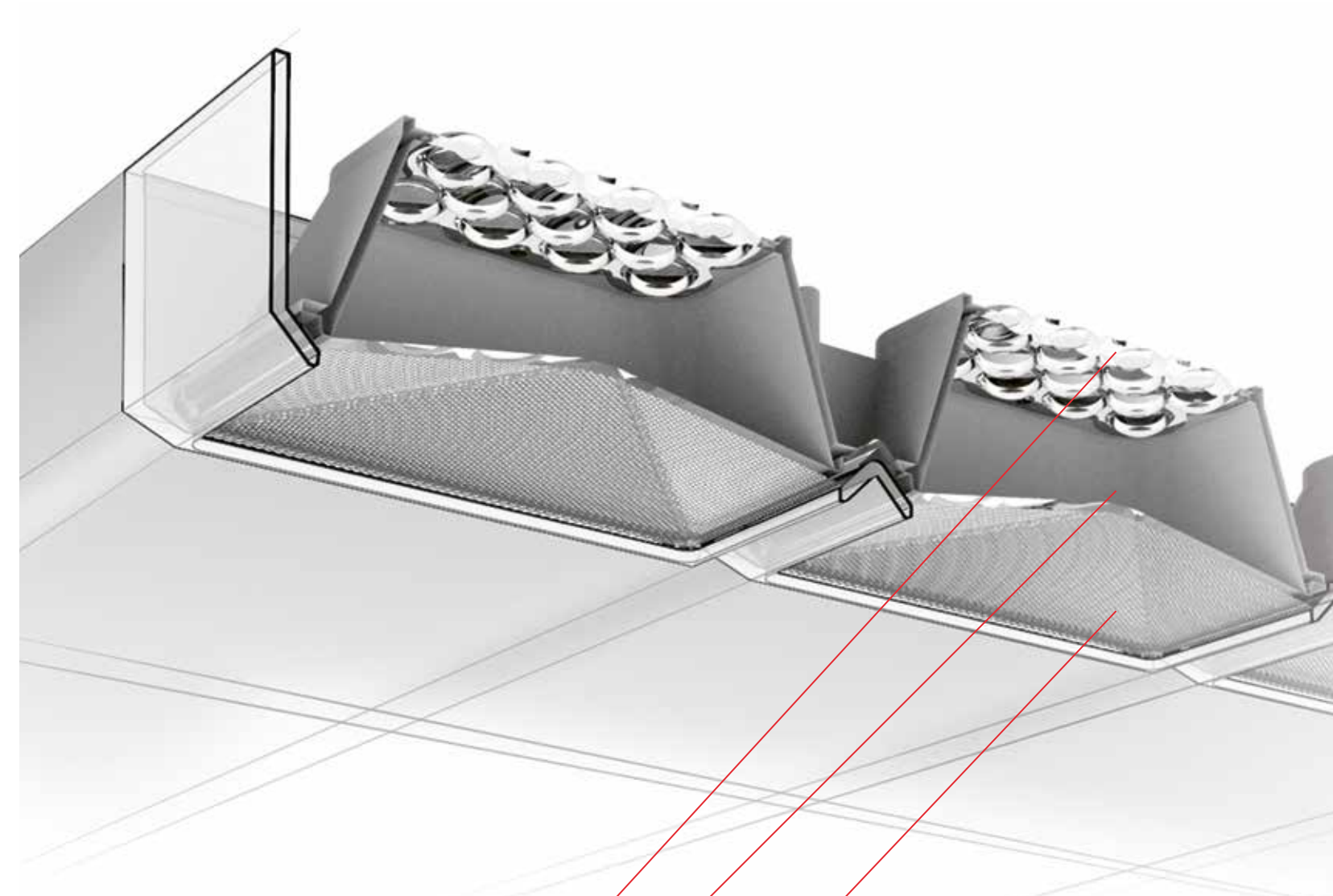

Primary lens cluster: for primary light control and the first step in glare reduction

Blending chamber: highly reflective material for best efficiency, light blending and homogenization as well as top results with Tunable White

Patented Micro Lens Array: structure made of 8,000 aspheric micro-lenses for precise light distribution and capable of achieving UGR values as low as 16

Available color variants:



Compact design with 64 x 64 mm housing for a purist design and attractive proportions

Seamless continuous row mounting: integration of the driver behind the LED modules enables seamless continuous rows and dispenses with large ECG canopy

Also available with Tunable White function as the ideal basis for HCL^{live} applications for increased motivation and well-being

Hybrid optic system composed of lenses and reflectors – perfect glare elimination in longitudinal and transverse axes for high visual comfort even with large lumen packages

Highest efficiency up to 160 lm/W due to state of the art LED technology for low operating costs – can be further optimized via optional presence and daylight sensors

Silica[®] luminaire family

Compact, straightforward and well thought-out – office lighting in a new light.

Silica[®] brings together simplicity and elegance in a high-quality linear housing. The integrated ECG enables seamless continuous rows with a variety of individualization options. Silica[®] stands for lighting technology at the highest level and is ideally suited for our HCL^{live} applications thanks to Tunable White. The hybrid optic system with optimum glare control creates the ideal preconditions for pleasant work at screen-based workstations.

1 Silica[®] ceiling surface-mounted

Ceiling surface mounting as the simplest route to modern, stylish office lighting

2 Silica[®] ceiling-recessed

Integrated design through flush fitting

3 Silica[®] suspended mounting

Pleasant working light from the indirect component of the pendant luminaire – the ideal basis for HCL^{live} applications

4 Silica[®] floorstanding upright

Floorstanding upright completes the luminaire range for a uniform lighting solution and enhanced interior design via indirect light component

Scriptus®

Progressive, contemporary design with outstanding efficiency and quality of light.

Designed by the Berlin-based Aisslinger studio, the product family is characterized by high-quality design coupled with innovative technology for future-looking, human-centric working environments. Scriptus® features a purist elegance, concise lines and maximum system flexibility.

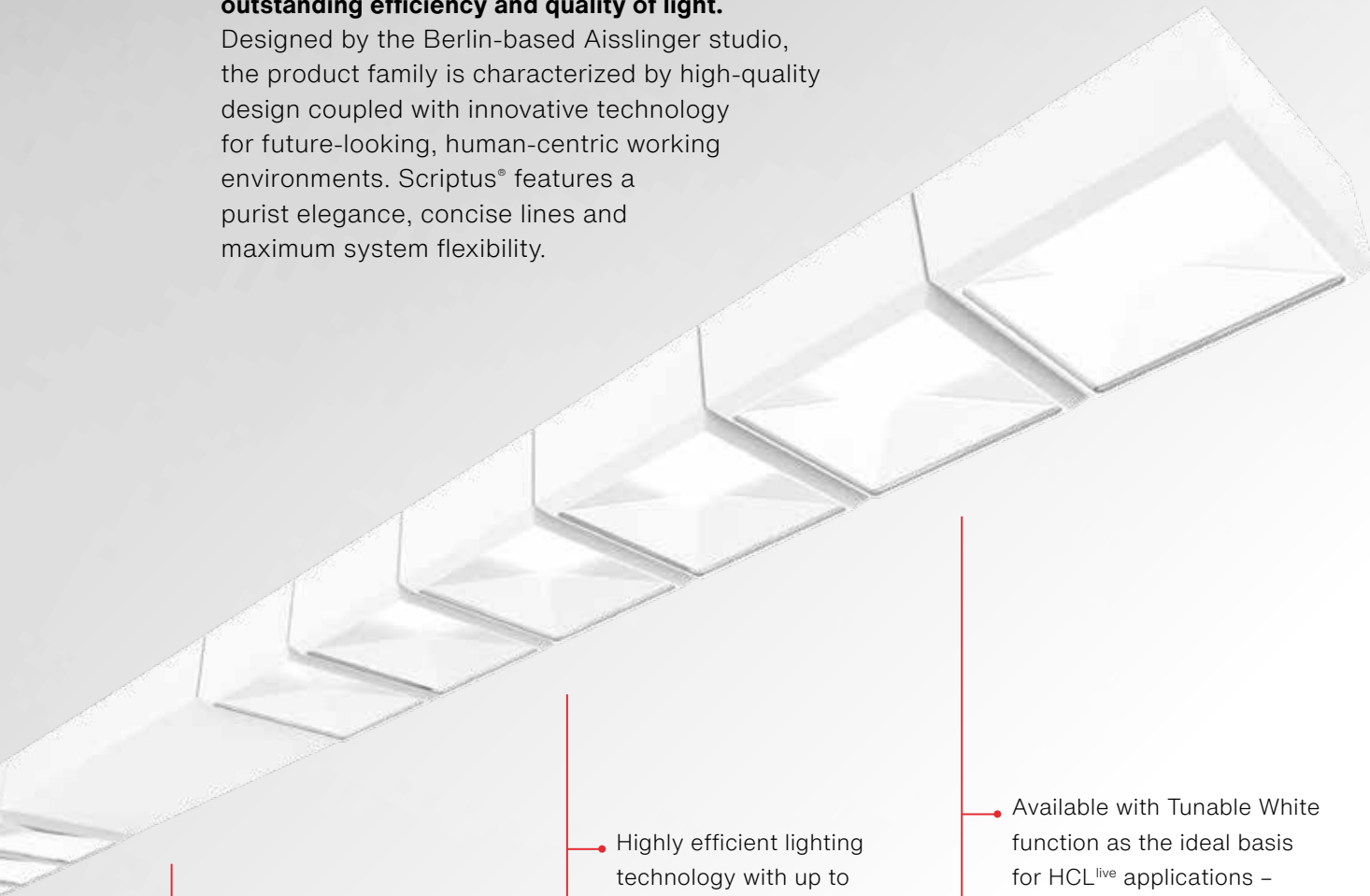

- Luminaire range for ceiling surface mounting or suspended mounting as well as individual ceiling recessed variants – also available as variant for convenient modernization of conventional ceiling systems

- Highly efficient lighting technology with up to 135 lm/W and CLO luminous flux tracking for low energy consumption and avoidance of overplanning

- High-quality optics technology with new, multi-step optic system for maximum visual comfort thanks to excellent glare control ($UGR \leq 16$) and uniform illumination

- Available with Tunable White function as the ideal basis for HCL^{live} applications – for greater well-being and motivation

- Maximum lighting design flexibility due to various configuration options as well as extensive control options – for example with DALI DT8 driver for simple integration into common building management systems



- Complete family with different forms and mounting options – available as variant for convenient modernization of conventional ceiling systems

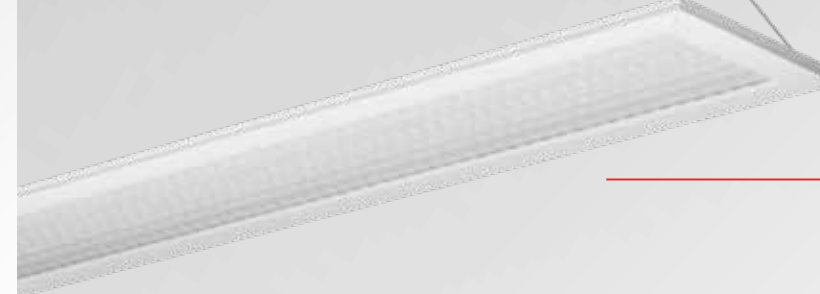

- Highly efficient for low energy consumption – with refurbishment projects (T5/T8), feasible energy savings of up to 55 %



- Durable, with protection ratings of up to IP54 – also suitable for more adverse environments and clean rooms

- Available with Tunable White function as the ideal basis for HCL^{live} applications – for greater well-being and motivation

- Maximum adaptation capability thanks to optional multilumen technology for different illuminances in one luminaire

- Very high color rendering value (CRI90), ideal for demanding visual tasks and wellbeing

Apollon® luminaire family

The intelligent luminaire family for office and basic lighting.

Apollon luminaires score with an integrative design, uniform illumination and advanced technology.



Individual light guide and lighting effect through various optics and filters – easy to replace thanks to sophisticated magnetic point technology

High quality, filigree design through flat construction and die-cast aluminium housing

Surface powder coated in RAL 9006 silver fine structure (optionally also in white, black or special colors)

Various lumen packages and color temperatures (2,700 – 4,000 K) for illumination according to your needs

Mira[®] luminaire family

Aesthetic design meets state-of-the-art lighting technology – designed by Gerhard Grimmeisen.

The ultra-flat construction and the transparent design generate a fascinating appearance. State-of-the-art optics technology enables the highest quality of light throughout the office – whether for accent or area lighting. A wide range of control and sensor options provide an additional level of flexibility. Open interfaces enable smooth integration into building management systems. Thanks to the dynamic control of light colors, the family is the perfect companion for HCL^{live}.

The Mira[®] family of luminaires is a joint development of GRIMMEISEN and SITECO. The adapted design and product concept in form, colour and surface aims at a special variety of effects and combines the design competence of GRIMMEISEN and 150 years of experience in lighting technology of SITECO.

- 1 Mira Box
- 2 Mira Flex
- 3 Mira Move
- 4 Mira Floor
- 5 Mira Circ
- 6 Mira Air



- Aesthetic flat design with a housing height of only 18 mm
- Luminaire body seamlessly made of die-cast aluminium

Surface powder coated in RAL 9006 silver fine structure (optionally also in white, black or special colors)

Hardened display glass (acrylic glass), all-round edge area in 3-fold screen printing (2K) color "silverstone metallic"

Optics (LDP) with embossed micro-prism structure for high efficiency at best glare suppression

Licross® Trunking

14 cores and full flexibility are a must-have for tomorrow.

45 years of experience – trunking *Made in Germany* perfected in our new Licross® trunking system.

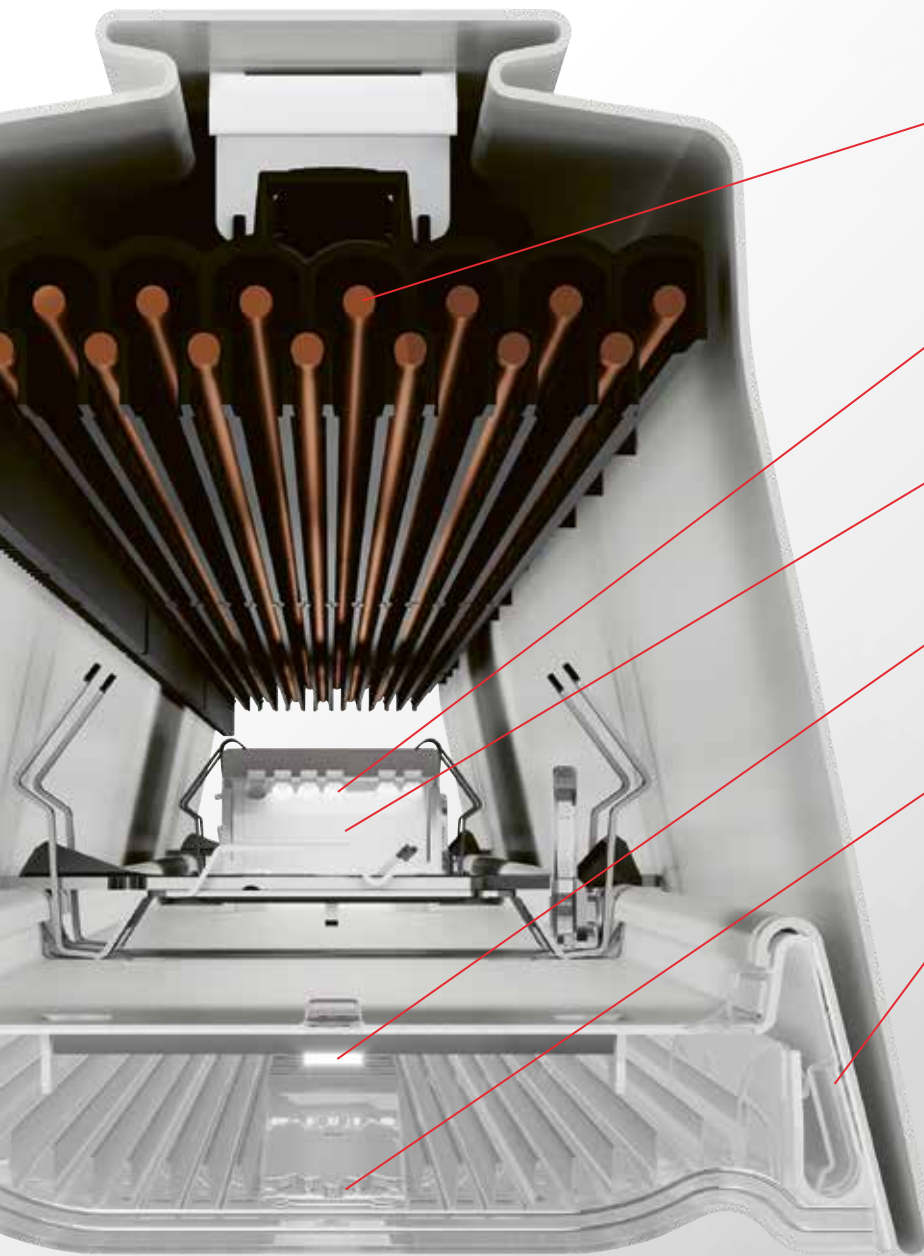

14 cores for optimal networking, diverse enhancements and integrated emergency lighting – and easy to install with a simple click system

System service life up to 100,000 hours for sustainable and plannable investments

Maximum photometric efficiency of up to 200 lm/W for low operating costs and quick payback times

Optimum glare control to UGR < 19 and high illuminances for safety and high visual comfort

The ideal basis for SITECO HCL^{live} for improving motivation and well-being

One-for-all concept with diverse luminaire inserts and a unique combination of multi-lumen capability and CLOi for maximum adaptability

14 cores for a new level of networking.

Free lines in the Licross® trunking system enable ultra-fast data transmission to the device of your choice. Standardized Ethernet sockets installed by us in the trunking system enable the connection of a wide range of IT equipment such as cameras and audio systems thanks to a well thought-out family concept.

This enables you to bundle smart technology on the luminaire and thus optimize the space and appearance of your building ceilings. You simultaneously reduce the complexity of the systems control and can reduce the fire load of your building.

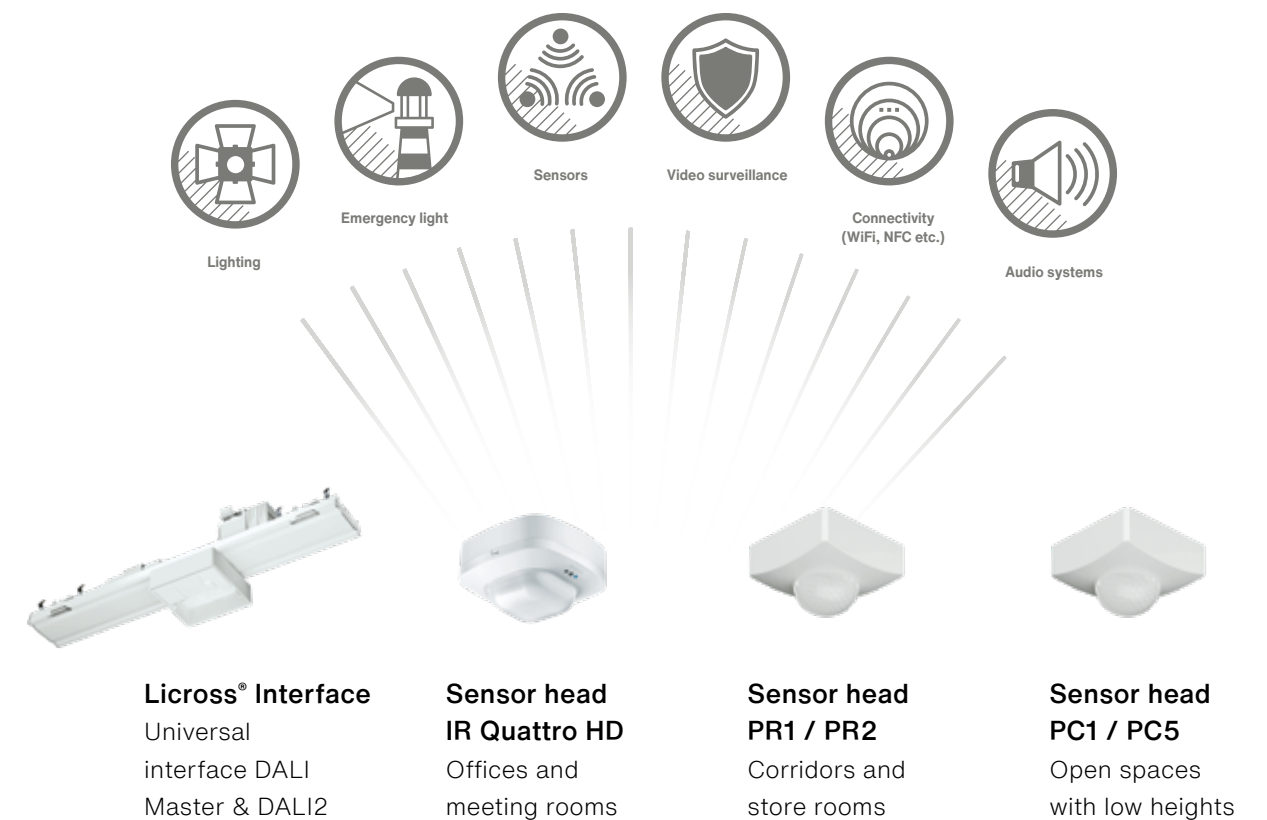

Licross® luminaire inserts

The right technology for any application in one product family.

Whether general, zonal or accent lighting or spotlights, shelf or wallwasher applications. Licross® luminaire inserts offer the greatest possible scope for configuration with precisely matching results. Additional customizing options allow even more flexibility.



Licross® Spot

- Powerful, point-based light sources for brilliant scene-setting and optimized light distribution
- Exceptional accentuated lighting due to sophisticated optics and color temperatures for shelves, wall surfaces and aisle illumination



Licross® Wall- / Shelfwasher

- Accentuated lighting and outstanding color rendering for attractive interior design
- Harmonious housing design with a slender shape and simultaneously high flexibility due to numerous configuration options

All inserts are available in the following colors:



Licross® Performance

- Special optical technology for very high visual comfort with up to UGR < 19 and suitability for screen-based workstations
- Attractive interior design with up to 23 % indirect light component – ideal for SITECO HCL^{live}



Project: Constantin-Vanotti-School,
Überlingen, Germany
Product: Licross® trunking system



Project: Siemens Flow Goods, Sonderborg, Denmark
Product: DL® 20

DL® 20

The design benchmark among road luminaires.

- Precise light distribution due to double reflector technology in MIRO® quality for different road and plaza situations, and optimum glare control – allowing even a glare-free view into the luminaire
- Filigree design with resistant workmanship (IP66, IK08), dirt-resistant toughened safety glass and low-maintenance continuous operation of up to 100,000 hours with minimum luminous flux degradation thanks to optimal thermal management

DL® 30

Fresh urban aesthetics.

- Decorative post-top luminaire for good quality of light and visual comfort in residential and urban areas – also available with 270° optic specifically developed for intersections
- Modern lighting technology with specific light distributions, for glare-free light with constant lighting quality and efficiency thanks to high-quality specular reflectors and permanently clear PMMA cover

DL® 50

The urban all-rounder.

- Decorative technical solution available as mast and catenary variants and in two construction sizes for all urban applications with a modular design saving time and resources
- Precise, glare-free light via HD faceted reflector and precisely defined light distributions for high visual comfort and safety



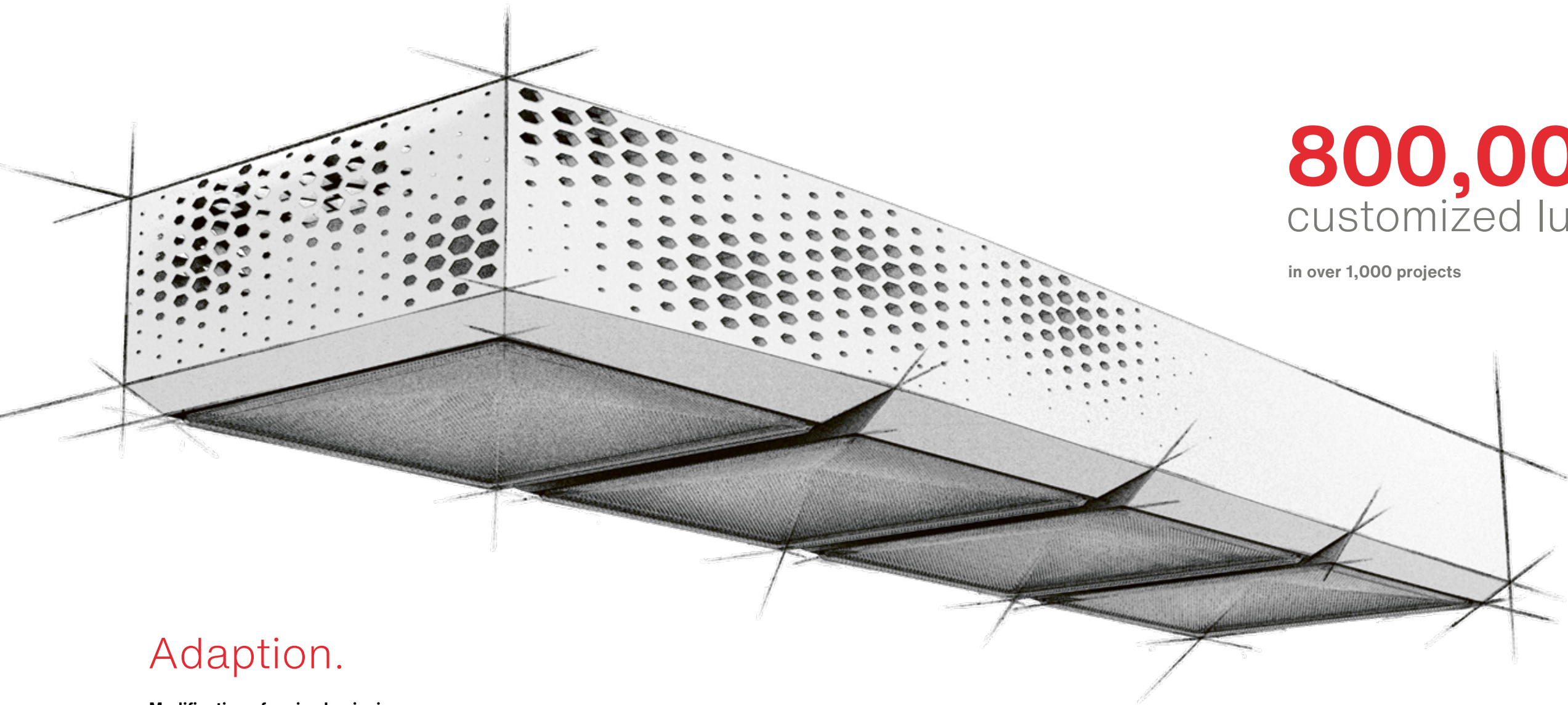

800,000
customized luminaires

in over 1,000 projects

Adaption.

Modification of series luminaires

- Changing the light color and color rendering
- Changing the housing dimensions, colors and mounting accessories

Combination.

Modular construction system

- Versatile combinable systems for your ideal project solution
- Modular SITECO optic platforms as the basis for your project luminaire

Creation.

Special luminaire development

- Concept development and project management
- Construction planning and special luminaire construction with an experienced development team

Ideal customer proximity via flexibility and speed.

When the options in the catalogue end, the almost infinite variety of customized options begin.

SITECO offers a wide spectrum of customized solutions thanks to its experienced team of designers and engineers. *Made in Germany* also means we provide additional flexibility and speed.



Lighting solutions

One of many topics for you, but for us it's everything.

Outstanding lighting technology provides the perfect foundation. In addition, our claim is to also make a significant contribution to the future viability of our customers.

For this reason SITECO solutions include the complete spectrum of services, ranging from planning and project management to the financing and operation of your system.

SITECO assumes responsibility for your light.

Complex is fine. But not complicated.

Whether functional lighting or complex lighting solutions – each project is individual and depends on the lighting requirements, the existing conditions and the architectural demands. SITECO supports you in defining these parameters and converting them into an overall concept. We also speak your language – putting complex technologies into plain words. This is how we make sure that your specific requirements are taken into account and successfully implemented in the project.

SITECO – the planning and development partner for your lighting solution.

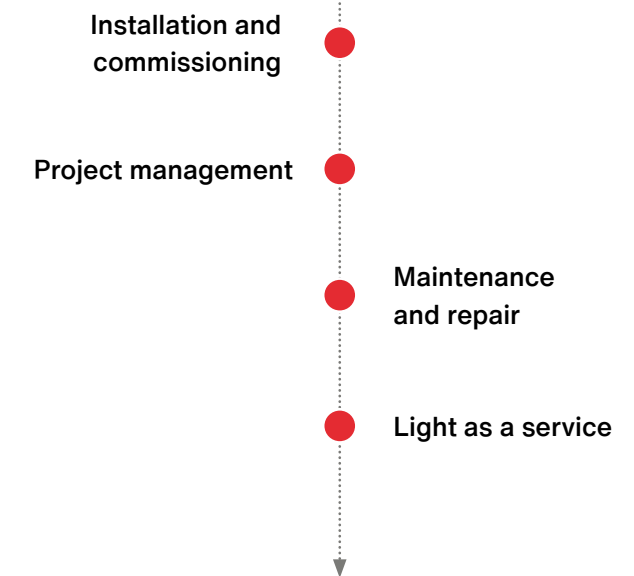
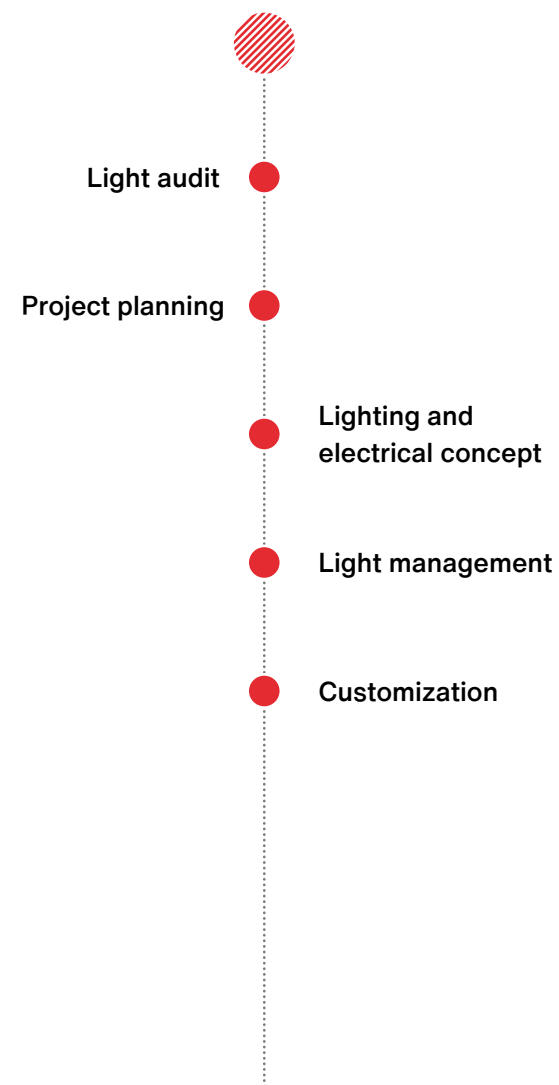

Your time and your budget are not infinite.

Modern lighting systems not only require precise planning but also precise implementation. This often results in high organizational and coordination effort – which should not result in a decision against the project. Concerns about high investment costs should also not hinder project progress. The systematic modernization of lighting systems usually pays for itself through lower operating costs.

We have a network of reliable partners ranging from installers to programmers to provide you with turnkey solutions. We also offer you individual financing solutions, for example monthly installments or individual leasing contracts. You decide whether CAPEX or OPEX and whether we take over your maintenance at the same time.

SITECO guarantees the success of your project.

Contact.

Siteco GmbH

Georg-Simon-Ohm-Str. 50
83301 Traunreut
Germany
Tel. +49 8669 330
info@siteco.de

www.siteco.com

Technical support

Tel. +49 8669 338 44
technicalsupport@siteco.de

Team Office.

Werner Rentschler

Head of Product Management
Office
Tel. +49 8669 335 35
w.rentschler@siteco.de

Team Projects & Services.

Christian Fleindl

Head of Customized Solutions
Tel. +49 8669 334 28
c.fleindl@siteco.de

For reasons of readability, the brochure largely dispenses from using gender-specific formulations.
If personal designations are only provided in masculine form they refer to persons of every gender.

Order number 810P011GB | SITECO Marketing 02.2020 | Technical modifications and errors reserved.



