

Order No.: 5XCMOD1A2DC | **GTIN (EAN):** 4058352391785

Product description: SL11,Plusmc,LEDmod,ST1.2a,722

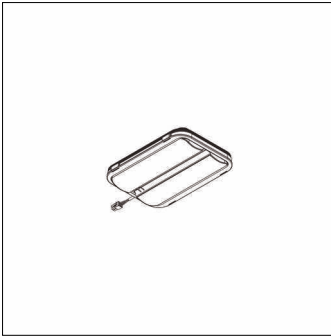

Streetlight SL 11 Plus micro, LED module, light distribution: ST1.2a, primary light characteristic: asymmetric, High Power LED, light colour: 722, colour temperature: 2200K, mains connection: 230V, 50Hz, LED module, protection rating (complete): as luminaire, packaging unit: 1 piece

Wt. (kg): 0.4
GTIN (EAN): 4058352391785

Order No.: 5XCMOD1A2DC | GTIN (EAN): 4058352391785

Detailed technical description: SL11,Plusmc,LEDmod,ST1.2a,722

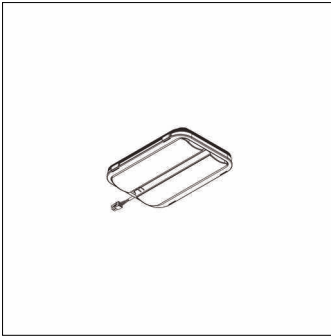

Key data

- Product type: LED module
- Product name: Streetlight SL 11 Plus micro
- Order No.: 5XCMOD1A2DC

Lighting technology | Lamps | Control gear

Component 1

Lighting technology:

- Light distribution: ST1.2a
- Beam angle: wide distribution
- Symmetry: asymmetric distribution

Lamps:

- Lamps: with High Power LED
- Colour temperature: 2200K
- Colour rendering index: CRI > 70
- Light colour: 722

Certificates, Standards

- Protection rating: as luminaire

Electrical connection

- Nominal voltage: 230V, 50Hz

Dimensions, Weight

- Weight: 0.4kg