

**Order No.:** 5XCMOD1C2DC | **GTIN (EAN):** 4058352391884

**Product description:** SL11,Plusmc,LEDmod,P1.0a,722

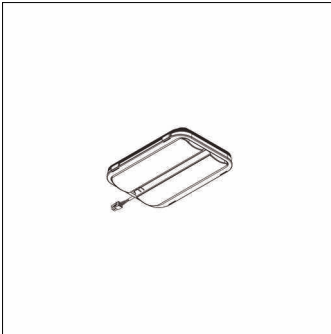

Streetlight SL 11 Plus micro, LED module, primary light control with cycle path optic, light distribution: P1.0a, primary light characteristic: asymmetric, High Power LED, light colour: 722, colour temperature: 2200K, mains connection: 230V, 50Hz, LED module, protection rating (complete): as luminaire, packaging unit: 1 piece

Wt. (kg): 0.3  
GTIN (EAN): 4058352391884

Order No.: 5XCMOD1C2DC | GTIN (EAN): 4058352391884

Detailed technical description: SL11,Plusmc,LEDmod,P1.0a,722

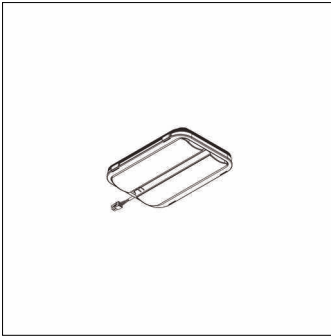

#### Key data

- Product type: LED module
- Product name: Streetlight SL 11 Plus micro
- Order No.: 5XCMOD1C2DC

#### Lighting technology | Lamps | Control gear

##### Component 1

#### Lighting technology:

- Light control: cycle path optic
- Light distribution: P1.0a
- Beam angle: extremely wide distribution
- Symmetry: asymmetric distribution

#### Lamps:

- Lamps: with High Power LED
- Colour temperature: 2200K
- Colour rendering index: CRI > 70
- Light colour: 722

#### Certificates, Standards

- Protection rating: as luminaire

#### Electrical connection

- Nominal voltage: 230V, 50Hz

#### Dimensions, Weight

- Weight: 0.3kg