

Order No.: 5MN238DLE003 | GTIN (EAN): 4050737963846

Product description: Vega11,7300lm830,DA

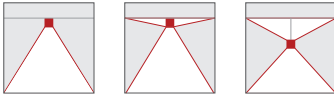

Vega 11, office luminaire, primary light control with prismatic reflector, of PMMA, transparent prismatic structure, CAT 2 ($L \leq 1500 \text{cd/m}^2$), light emission: direct/indirect distribution, primary light characteristic: symmetric, installation type: suspended mounting, surface-mounted, LED, rated luminous flux: 7.300lm, luminous efficacy: 118lm/W, light colour: 830, colour temperature: 3000K, control gear: DALI, with terminal, 3+2-pole, max. 2.5mm², mains connection: 230V, AC, 50Hz, connection cable inclusive, cable length: 1,5m, rated input power: 62W, luminaire housing, rectangular, rounded, of aluminium section, anodised, metallic grey (RAL 9006), length: 1.250mm, width: 350mm, height: 43mm, luminaire housing, lower part, of aluminium section, anodised, metallic grey (RAL 9006), of PC, grey, protection rating (complete): IP20, insulation class (complete): insulation class I (protective earthing), certification: CE, standard: EN 50419, packaging unit: 1 piece

4050737963846
5MN238DLE003

LED 3000K / CRI \geq 80 Φ_N 7300 lm

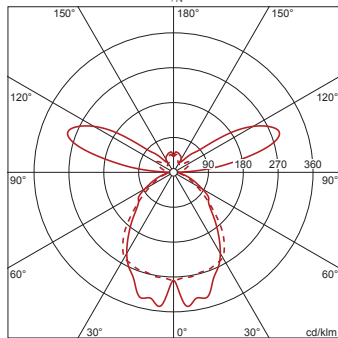

IP 20

Lamps:	LED
Wt. (kg):	6.5
GTIN (EAN):	4050737963846

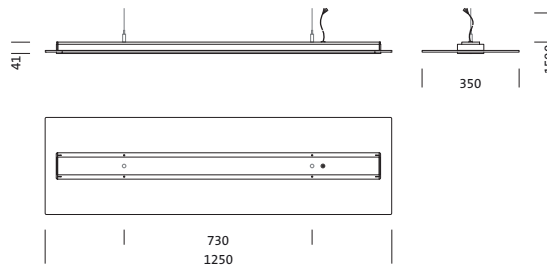

Order No.: 5MN238DLE003 | GTIN (EAN): 4050737963846

Detailed technical description: Vega11,7300lm830,DA



Key data

- Product type: office luminaire
- Product name: Vega 11
- Order No.: 5MN238DLE003

Lighting technology | Lamps | Control gear

Component 1

Lighting technology:

- Light control: prismatic reflector of PMMA, transparent prismatic structure
- Symmetry: symmetric
- Light emission: direct/indirect distribution, 60:40
- UGR viewing direction along longitudinal luminaire axis: ≤ 16
- UGR viewing direction along lateral luminaire axis: ≤ 16

Lamps:

- Lamps: with LED
- Rated luminous flux: 7300lm
- Luminous efficacy: 118lm/W
- Colour temperature: 3000K
- Colour rendering index: CRI > 80
- Light colour: 830
- SDCM (Standard Deviation of Colour Matching): MacAdam ≤ 3 SDCM (initial)
- Rated input power: 62W

Operating device:

- Control gear: ECG
- Control: DALI

Certificates, Standards

- Protection rating: IP20
- Insulation class: insulation class I (protective earthing)
- Standard: EN 50419
- Certification, designation: CE

Material, Colour

- luminaire housing: aluminium section, anodised, metallic grey (RAL 9006), rectangular, rounded
- luminaire housing, lower part: aluminium section, anodised, metallic grey (RAL 9006)

Mounting

- Mounting method, mounting location: suspended mounting, surface-mounted
- Arrangement: single arrangement

Electrical connection

- Connection: terminal, 3+2-pole, max. 2.5mm²
- Nominal voltage: 230V, 220..240V, 50Hz, AC
- Connection cable: inclusive, L= 1.5m

Dimensions, Weight

- Length: 1250mm
- Width: 350mm
- Height: 43mm
- Weight: 6.5kg

Service life

- Rated service life: 50000h (L80/B50) at AT = 25°C

Order No.: 5MN238DLE003 | GTIN (EAN): 4050737963846

Dimensions: Vega11,7300lm830,DA

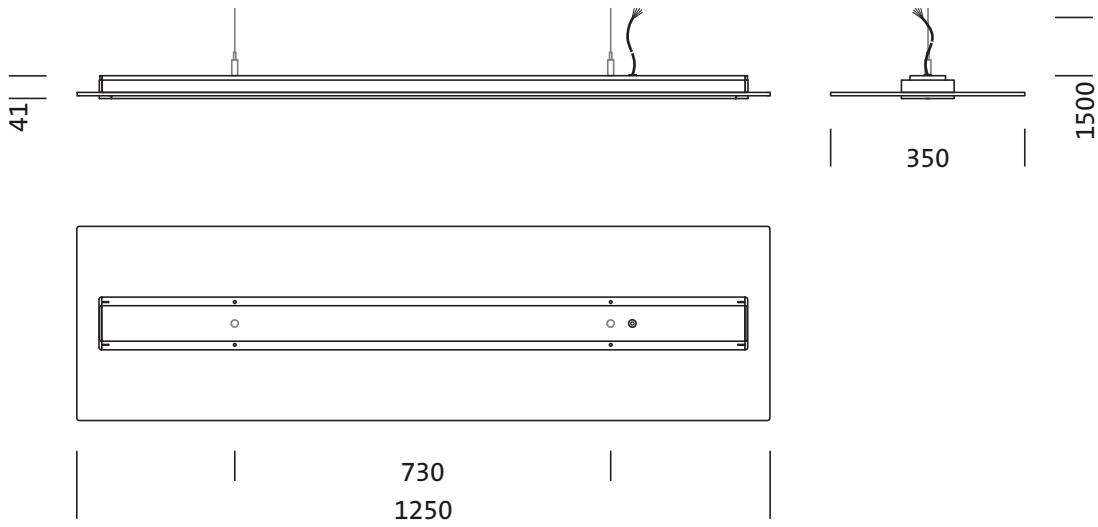

It is mandatory that the assembly instructions must be observed when planning and installing the electrical installation (to be found at www.siteco.de)
Tolerances related to thermal, electrical and photometric data according to IEC 62722
Issued 14.02.2026 - Modifications and errors subject to change - Ensure that you always use the latest version -

Order No.: 5MN238DLE003 | GTIN (EAN): 4050737963846

Planning data: Vega11,7300lm830,DA

**5MN238DLE003: 1x LED
3000K / CRI ≥ 80**

4050737963846
5MN238DLE003

LED 3000K / CRI ≥ 80 ϕ_N 7300 lm

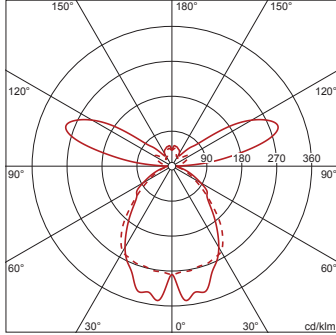

No. of luminaires in room
Reflection factors 70/50/20

Em(lx)	100		200		500	
	Lh(m)	2.5	3.0	2.5	3.0	2.5
20 m ²	0.5	0.6	1.0	1.1	2.5	2.8
30 m ²	0.8	0.8	1.5	1.6	3.8	4.1
40 m ²	0.9	1.0	1.9	2.0	4.6	5.1
50 m ²	1.1	1.2	2.2	2.4	5.6	6.1
75 m ²	1.7	1.7	3.3	3.5	8.3	8.7
100 m ²	2.1	2.2	4.2	4.5	11	11
500 m ²	9.4	9.6	19	19	47	48

Maintenance factor 0.8

Rh = Lh + 0.5 m

**5MN238DLE003 + 5MN91401:
1x LED 3000K / CRI ≥ 80**

4050737963846 + 4050737754987
5MN238DLE003 + 5MN91401

LED 3000K / CRI ≥ 80 ϕ_N 7100 lm

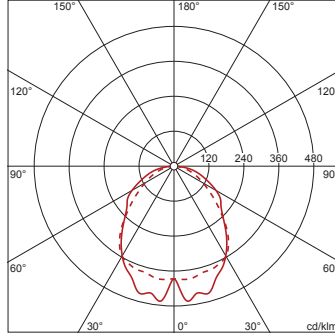

No. of luminaires in room
Reflection factors 70/50/20

Em(lx)	100		200		500	
	Lh(m)	2.5	3.0	2.5	3.0	2.5
20 m ²	0.4	0.5	0.8	1.0	2.1	2.4
30 m ²	0.6	0.7	1.2	1.4	3.1	3.4
40 m ²	0.8	0.9	1.6	1.7	3.9	4.3
50 m ²	0.9	1.0	1.9	2.1	4.7	5.2
75 m ²	1.4	1.5	2.8	3.0	7.0	7.4
100 m ²	1.8	1.9	3.6	3.8	9.0	9.6
500 m ²	8.2	8.5	16	17	41	42

Maintenance factor 0.8

Rh = Lh

**5MN238DLE003 + 5MN91402:
1x LED 3000K / CRI ≥ 80**

4050737963846 + 4050737755007
5MN238DLE003 + 5MN91402

LED 3000K / CRI ≥ 80 ϕ_N 7210 lm

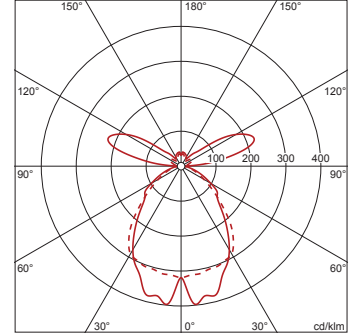

No. of luminaires in room
Reflection factors 70/50/20

Em(lx)	100		200		500	
	Lh(m)	2.5	3.0	2.5	3.0	2.5
20 m ²	0.5	0.5	1.0	1.1	2.4	2.7
30 m ²	0.7	0.8	1.4	1.6	3.6	3.9
40 m ²	0.9	1.0	1.8	1.9	4.4	4.9
50 m ²	1.1	1.2	2.1	2.3	5.4	5.8
75 m ²	1.6	1.7	3.2	3.3	8.0	8.4
100 m ²	2.0	2.2	4.1	4.3	10	11
500 m ²	9.1	9.4	18	19	46	47

Maintenance factor 0.8

Rh = Lh + 0.5 m

It is mandatory that the assembly instructions must be observed when planning and installing the electrical installation (to be found at www.siteco.de)

Tolerances related to thermal, electrical and photometric data according to IEC 62722

Issued 14.02.2026 - Modifications and errors subject to change - Ensure that you always use the latest version -