

Order No.: 51DB15MD3C | GTIN (EAN): 4058352555156

Product description: Lun21L,Ø150,1670lm830,MLwh



Lunis 21, L, downlight, of PC, light emission: direct distribution, LED rated luminous flux: 1.670lm, light colour: 830, control gear: ECG, with terminal, 3-pole, mains connection: 220..240V, AC, housing, round, of diecast aluminium, traffic white (RAL 9016), diameter: 162mm, protection rating (complete): IP20, protection rating (on room side): IP54, insulation class (complete): insulation class II (safety insulation), certification: CE, impact resistance: IK02, packaging unit: 1 piece

IP 20  

Lamps:	LED
Wt. (kg):	0.6
GTIN (EAN):	4058352555156

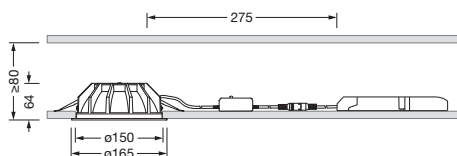

It is mandatory that the assembly instructions must be observed when planning and installing the electrical installation (to be found at www.siteco.de)

Tolerances related to thermal, electrical and photometric data according to IEC 62722

Issued 15.03.2024 - Modifications and errors subject to change - Ensure that you always use the latest version -

Order No.: 51DB15MD3C | GTIN (EAN): 4058352555156

Detailed technical description: Lun21L,Ø150,1670lm830,MLwh



Key data

- Product type: downlight
- Product name: Lunis 21 L
- Order No.: 51DB15MD3C

Lighting technology | Lamps | Control gear

Component 1

Lighting technology:

- Beam angle: wide distribution
- Light emission: direct distribution
- UGR viewing direction along longitudinal luminaire axis: ≤ 19
- UGR viewing direction along lateral luminaire axis: ≤ 19

Lamps:

- Lamps: with LED
- Rated luminous flux: 1670lm
- Luminous efficacy: 121lm/W
- Colour temperature: 3000K
- Colour rendering index: CRI > 80
- Light colour: 830
- SDCM (Standard Deviation of Colour Matching): MacAdam ≤ 3 SDCM (initial)
- Rated input power: 14W
- Supplement: halogen-free wiring

Operating device:

- Control gear: ECG
- Control: ON/OFF Multilumen

Certificates, Standards

- Protection rating: IP20
- Protection rating (on room side): IP54
- Insulation class: insulation class II (safety insulation)
- Impact resistance: IK02
- Certification, designation: CE

Material, Colour

- housing: diecast aluminium, traffic white (RAL 9016), round
- Colour specification: traffic white (RAL 9016)

Mounting

- Mounting method, mounting location: recessed, in the ceiling
- \varnothing of ceiling cut-out: 150mm
- Arrangement: single arrangement

Electrical connection

- Connection: terminal, 3-pole
- Nominal voltage: 220..240V, AC

Dimensions, Weight

- Diameter: 162mm
- Height: 58mm
- Weight: 0.6kg

Service life

- Rated service life: 50000h (L80/B50) at AT = 25°C

Order No.: 51DB15MD3C | GTIN (EAN): 4058352555156

Dimensions: Lun21L, Ø150, 1670lm830, MLwh

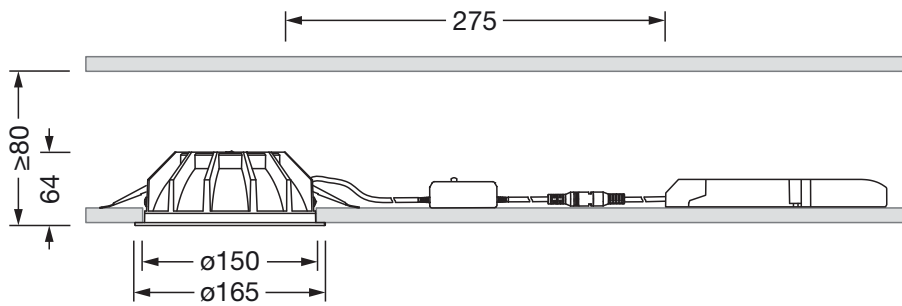

It is mandatory that the assembly instructions must be observed when planning and installing the electrical installation (to be found at www.siteco.de)

Tolerances related to thermal, electrical and photometric data according to IEC 62722

Issued 15.03.2024 - Modifications and errors subject to change - Ensure that you always use the latest version -