

Order No.: 5NY231735AM00 | GTIN (EAN): 4039806381576

Product description: mast,cyl.off,steel,galv,3.5m,Ø76



mast, mast, cylindrical offset, of steel, galvanised, height: 3.5m, spigot size: 76mm (post-top), planted section: h= 600mm / Ø= 114mm, standard: DIN EN 40, packaging unit: 1 piece

Wt. (kg): 27.4
GTIN (EAN): 4039806381576

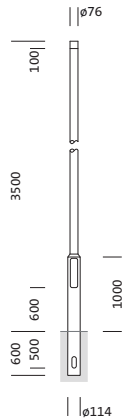

It is mandatory that the assembly instructions must be observed when planning and installing the electrical installation (to be found at www.siteco.de)
Tolerances related to thermal, electrical and photometric data according to IEC 62722
Issued 22.12.2023 - Modifications and errors subject to change - Ensure that you always use the latest version -

Order No.: 5NY231735AM00 | GTIN (EAN): 4039806381576

Detailed technical description: mast,cyl.off,steel,galv,3.5m,Ø76

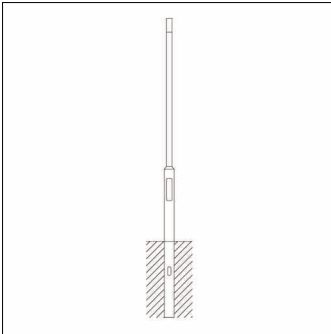

Key data

- Product type: mast
- Product name: mast
- Order No.: 5NY231735AM00

Certificates, Standards

- Standard: DIN EN 40

Material, Colour

- mast: steel, galvanised, cylindrical offset

Dimensions, Weight

- Height: 3.5m
- Weight: 27.4kg
- Mast spigot: spigot size: 76mm
- Planted section: h= 600mm / Ø= 114mm

Order No.: 5NY231735AM00 | GTIN (EAN): 4039806381576

Dimensions: mast,cyl.off,steel,galv,3.5m,Ø76

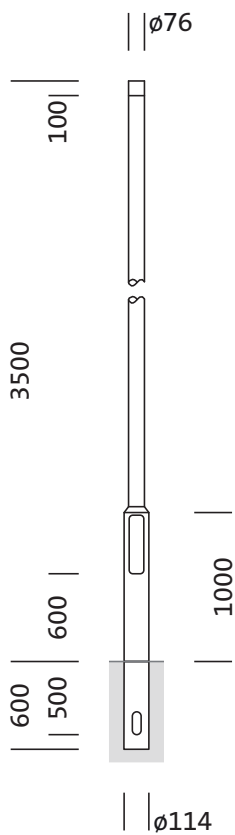

It is mandatory that the assembly instructions must be observed when planning and installing the electrical installation (to be found at www.siteco.de)

Tolerances related to thermal, electrical and photometric data according to IEC 62722

Issued 22.12.2023 - Modifications and errors subject to change - Ensure that you always use the latest version -