

Order No.: 51DT137A41A | GTIN (EAN): 4058352510025

Product description: Lun41Sp,Ø68,550lm840,0/1wh



Lunis 41, Spot, downlight, light emission: direct distribution, LED rated luminous flux: 550lm, light colour: 840, control gear: ECG, mains connection: 230V, AC, 50/60Hz, housing, round, of aluminium, coated, traffic white (RAL 9016), diameter: 88mm, recess depth: 54mm, protection rating (complete): IP20, protection rating (on room side): IP20, insulation class (complete): insulation class II (safety insulation), certification: CE, permissible ambient temperature for indoor applications: -20..+40°C, packaging unit: 1 piece

IP 20  

Lamps: LED
 Wt. (kg): 0.1
 GTIN (EAN): 4058352510025

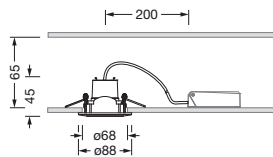

It is mandatory that the assembly instructions must be observed when planning and installing the electrical installation (to be found at www.siteco.de)

Tolerances related to thermal, electrical and photometric data according to IEC 62722

Issued 15.03.2024 - Modifications and errors subject to change - Ensure that you always use the latest version -

Order No.: 51DT137A41A | GTIN (EAN): 4058352510025

Detailed technical description: Lun41Sp,Ø68,550lm840,0/1wh



Key data

- Product type: downlight
- Product name: Lunis 41 Spot
- Order No.: 51DT137A41A

Service life

- Rated service life: 30000h (L70/B50) at AT = 25°C

Lighting technology | Lamps | Control gear

Component 1

Lighting technology:

- Light emission: direct distribution

Lamps:

- Lamps: with LED
- Rated luminous flux: 550lm
- Luminous efficacy: 110lm/W
- Colour temperature: 4000K
- Colour rendering index: CRI > 80
- Light colour: 840
- Rated input power: 5W

Operating device:

- Control gear: ECG
- Control: ON/OFF

Certificates, Standards

- Protection rating: IP20
- Protection rating (on room side): IP20
- Insulation class: insulation class II (safety insulation)
- Temperature range (operation): - 20..+40°C
- Certification, designation: CE

Material, Colour

- housing: aluminium, coated, traffic white (RAL 9016), round
- Colour specification: traffic white (RAL 9016)

Mounting

- Mounting method, mounting location: recessed, in the ceiling
- Ø of ceiling cut-out: 68mm
- Arrangement: single arrangement

Electrical connection

- Nominal voltage: 230V, 50/60Hz, AC

Dimensions, Weight

- Diameter: 88mm
- Recess depth: 54mm
- Weight: 0.1kg

Order No.: 51DT137A41A | GTIN (EAN): 4058352510025

Dimensions: Lun41Sp,Ø68,550lm840,0/1wh

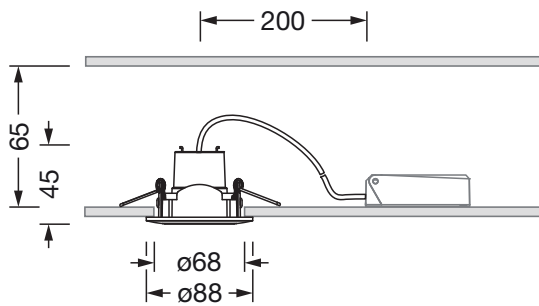

It is mandatory that the assembly instructions must be observed when planning and installing the electrical installation (to be found at www.siteco.de)

Tolerances related to thermal, electrical and photometric data according to IEC 62722

Issued 15.03.2024 - Modifications and errors subject to change - Ensure that you always use the latest version -