

Order No.: 5XE2D31Y08HB | **GTIN (EAN):** 4058352923382

Product description: SL21iQmn,ST1.0a,9750lm730,SR,D4i,LST



Streetlight SL 21 iQ mini, mast luminaire, primary light control with lens, of PMMA, primary optical cover: cover, of toughened safety glass, transparent, light distribution: ST1.0a, light emission: direct distribution, primary light characteristic: asymmetric, installation type: post-top, side-entry, LED, High Power LED, rated luminous flux: 9.750lm, luminous efficacy: 137lm/W, light colour: 730, colour temperature: 3000K, control: presetting dimming logarithmic, Street-Remote, Auto-Match, Temp-Guard, Lumen-Switch, Night-Set, Smart-Wire, Light-Fading, Desk-Remote (wireless, voltage-free reading and setting of iQ features in the workshop via application-optimized NFC function/RFID function), optimised constant luminous flux control (CLO 2.0), mains connection: 220..240V, AC, 50/60Hz, start of lifetime: 71W, end of service life: 75W, reduction: 30W, luminaire housing, of diecast aluminium, powder-coated, Siteco® metallic grey (DB 702S), corrosivity category C5 mid according to DIN EN ISO 12944, please order mast flange separately, inclination adjustable: 0°, 5°, 10°, 15°, sealing non-destructively replaceable, multi-level sealing system, length: 628mm, width: 235mm, height: 110mm, mast flange for spigot size: 42mm (side-entry): 5XC10008XM4, 60/48mm (side-entry/post-top): 5XC10108XM2, 76/60mm (side-entry/post-top): 5XC10108XM1, Smart Interface below and above, protection rating (complete): IP66, insulation class (complete): insulation class II (safety insulation), certification: CE, ENEC, VDE, impact resistance: IK09, permissible operating ambient temperature for outdoor applications: -40..+50°C, standard-compliant lighting for roads and squares, packaging unit: 1 piece



Lamps: LED
 Wt. (kg): 5.1
 GTIN (EAN): 4058352923382



Order No.: 5XE2D31Y08HB | GTIN (EAN): 4058352923382

Detailed technical description: SL21iQmn,ST1.0a,9750lm730,SR,D4i,LST



Key data

- Product type: mast luminaire
- Product name: Streetlight SL 21 iQ mini
- Order No.: 5XE2D31Y08HB

Lighting technology | Lamps | Control gear

Component 1

Lighting technology:

- Light control: lens of PMMA
- Cover: cover, transparent
- Light distribution: ST1.0a
- Beam angle: wide distribution
- Symmetry: asymmetric distribution
- Light emission: direct distribution

Lamps:

- Lamps: with High Power LED, LED
- Rated luminous flux: 9750lm
- Luminous efficacy: 137lm/W
- Colour temperature: 3000K
- Colour rendering index: CRI > 70
- Light colour: 730
- Rated input power begin service life: 71
- Rated input power end service life: 75
- Rated input power at 50% lumin. flux: 30

Operating device:

- Control: iQ-Street Remote, D4i with power reduction, Smart Interface below and above
- Equipment: optimised constant luminous flux control (CLO 2.0), Desk-Remote (wireless, voltage-free reading and setting of iQ features in the workshop via application-optimized NFC function/RFID function), Light-Fading, Smart-Wire, Night-Set, Lumen-Switch, Temp-Guard, Auto-Match, Street-Remote, presetting dimming logarithmic

Certificates, Standards

- Protection rating: IP66
- Insulation class: insulation class II (safety insulation)
- Impact resistance: IK09
- Temperature range (operation): -40..+50°C
- Supplement: standard-compliant lighting for roads and squares
- Corrosion protection: corrosivity category C5 mid according to DIN EN ISO 12944
- Certification, designation: CE, ENEC, VDE

Material, Colour

- luminaire housing: diecast aluminium, powder-coated, Siteco® metallic grey (DB 702S), please order mast flange separately, inclination adjustable: 0°, 5°, 10°, 15°, sealing non-destructively replaceable, multi-level sealing system
- Colour specification: Siteco® metallic grey (DB 702S)
- Cover: cover of toughened safety glass

Mounting

- Mounting method, mounting location: side-entry, post-top, on mast

Electrical connection

- Nominal voltage: 220..240V, 50/60Hz, AC
- Surge voltage resistance: surge voltage resistance: 10kV (common mode); 6kV (differential mode)

Dimensions, Weight

- Length: 628mm
- Width: 235mm
- Height: 110mm
- Weight: 5.1kg
- Mast spigot: mast flange for spigot size: 42mm (side-entry): 5XC10008XM4, 60/48mm (side-entry/post-top): 5XC10108XM2, 76/60mm (side-entry/post-top): 5XC10108XM1

Light emission

- Light emission: 0% at 0° inclination

Service life

- Rated service life: 100000h at AT = 25°C

It is mandatory that the assembly instructions must be observed when planning and installing the electrical installation (to be found at www.siteco.de)

Tolerances related to thermal, electrical and photometric data according to IEC 62722

Issued 13.04.2024 - Modifications and errors subject to change - Ensure that you always use the latest version -

Order No.: 5XE2D31Y08HB | GTIN (EAN): 4058352923382

Dimensions: SL21iQmn,ST1.0a,9750lm730,SR,D4i,LST

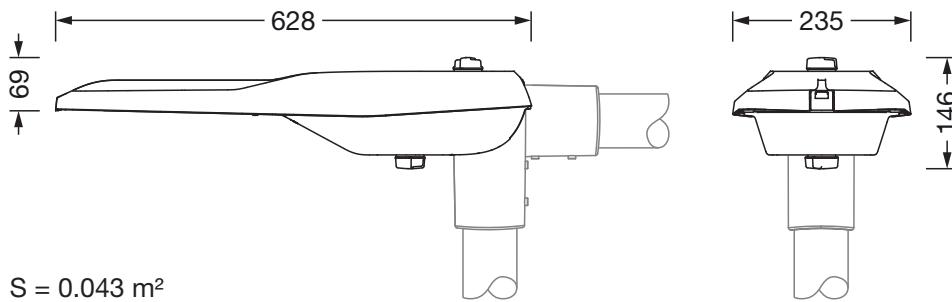

S = 0.043 m²