

**Order No.:** 5PJA012001A | **GTIN (EAN):** 4058352955093

**Product description:** Round31B,1800lm830,DA2,Ø290

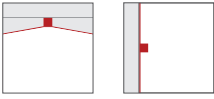

Round 31 B, wall and ceiling luminaire, primary optical cover: enclosure, of PMMA, light emission: direct distribution, primary light characteristic: symmetric, installation type: surface-mounted, LED, rated luminous flux: 1.800lm, luminous efficacy: 120lm/W, light colour: 830, colour temperature: 3000K, with terminal, 3+2-pole, max. 2.5mm<sup>2</sup>, mains connection: 230V, AC, 50/60Hz, rated input power: 15W, luminaire housing, round, of steel, white, diameter: 290mm, height: 85mm, protection rating (complete): IP40, insulation class (complete): insulation class I (protective earthing), certification: CE, impact resistance: IK02, permissible operating ambient temperature: -20..+25°C, packaging unit: 1 piece

IP 40  

Lamps:	LED
Wt. (kg):	0.8
GTIN (EAN):	4058352955093

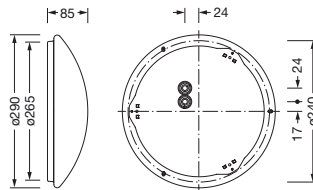

Order No.: 5PJA012001A | GTIN (EAN): 4058352955093

Detailed technical description: Round31B,1800lm830,DA2,Ø290



#### Key data

- Product type: wall and ceiling luminaire
- Product name: Round 31 B
- Order No.: 5PJA012001A

#### Dimensions, Weight

- Diameter: 290mm
- Height: 85mm
- Weight: 0.8kg

#### Lighting technology | Lamps | Control gear

#### Service life

- Rated service life: 50000h (L80/B10) at AT = 25°C

#### Component 1

#### Lighting technology:

- Cover: enclosure
- Beam angle: 120°
- Symmetry: symmetric distribution
- Light emission: direct distribution

#### Lamps:

- Lamps: with LED
- Rated luminous flux: 1800lm
- Luminous efficacy: 120lm/W
- Colour temperature: 3000K
- Colour rendering index: CRI > 80
- Light colour: 830
- SDCM (Standard Deviation of Colour Matching): MacAdam ≤ 3 SDCM (initial)
- Rated input power: 15W

#### Operating device:

- Control: DALI 2

#### Certificates, Standards

- Protection rating: IP40
- Insulation class: insulation class I (protective earthing)
- Impact resistance: IK02
- Temperature range (operation): -20...+25°C
- Certification, designation: CE

#### Material, Colour

- luminaire housing: steel, white, round
- Colour specification: white
- Cover: enclosure of PMMA

#### Mounting

- Mounting method, mounting location: surface-mounted, to the ceiling, to the wall
- Arrangement: single arrangement

#### Electrical connection

- Connection: terminal, 3+2-pole, max. 2.5mm<sup>2</sup>
- Nominal voltage: 230V, 50/60Hz, AC

Order No.: 5PJA012001A | GTIN (EAN): 4058352955093

Dimensions: Round31B,1800lm830,DA2,Ø290

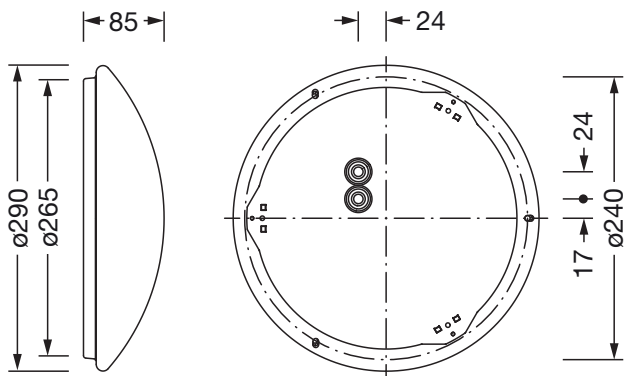

It is mandatory that the assembly instructions must be observed when planning and installing the electrical installation (to be found at [www.siteco.de](http://www.siteco.de))

Tolerances related to thermal, electrical and photometric data according to IEC 62722

Issued 26.01.2024 - Modifications and errors subject to change - Ensure that you always use the latest version -