

**Order No.:** 51DC312MD2400A | **GTIN (EAN):** 4069025359247

**Product description:** Lun11R,surf,bk3950lm830,ML



Lunis 11 R, downlight, light control with reflector, highly specular, light emission: direct distribution, LED rated luminous flux: 3.950lm, light colour: 830, with terminal, 3-pole, max. 2.5mm<sup>2</sup>, mains connection: 220..240V, AC, 50/60Hz, luminaire housing, of aluminium, black, diameter: 380mm, central ring, of plastic, black, central module, blanking cover, of sheet steel, perforated, white, protection rating (complete): IP20, insulation class (complete): insulation class I (protective earthing), certification: CE, permissible ambient temperature for indoor applications: ≤ +35°C, standard: EN 50419, packaging unit: 1 piece

IP 20  

Lamps: LED  
 Wt. (kg): 2.0  
 GTIN (EAN): 4069025359247

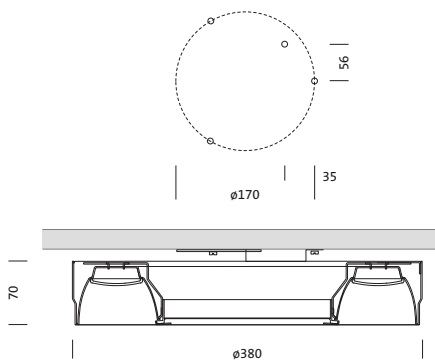

**Order No.:** 51DC312MD2400A | **GTIN (EAN):** 4069025359247

**Detailed technical description:** Lun11R,surf,bk3950lm830,ML



#### Key data

- Product type: downlight
- Product name: Lunis 11 R
- Order No.: 51DC312MD2400A

#### Lighting technology | Lamps | Control gear

#### Component 1

#### Lighting technology:

- Light control: reflector, highly specular
- Beam angle: wide distribution
- Symmetry: symmetric distribution
- Light emission: direct distribution

#### Lamps:

- Lamps: with LED
- Rated luminous flux: 3950lm
- Luminous efficacy: 156lm/W
- Colour temperature: 3000K
- Colour rendering index: CRI > 80
- Light colour: 830
- Rated input power: 25.3W

#### Operating device:

- Control: ON/OFF Multilumen

#### Certificates, Standards

- Protection rating: IP20
- Insulation class: insulation class I (protective earthing)
- Temperature range (operation):  $\leq +35^{\circ}\text{C}$
- Standard: EN 50419
- Certification, designation: CE

#### Material, Colour

- luminaire housing: aluminium, black
- Quantity: 1 piece
- Colour specification: black
- central ring: plastic, black
- Quantity: 1 piece
- Colour specification: black
- central module, blanking cover: sheet steel, perforated, white
- Quantity: 1 piece
- Colour specification: white

#### Mounting

- Mounting method, mounting location: surface-mounted, to the ceiling

#### Electrical connection

- Connection: terminal, 3-pole, max. 2.5mm<sup>2</sup>
- Nominal voltage: 220..240V, 230..240V, 50/60Hz, AC

#### Dimensions, Weight

- Diameter: 380mm
- Weight: 2.0kg

Order No.: 51DC312MD2400A | GTIN (EAN): 4069025359247

Dimensions: Lun11R,surf,bk3950lm830,ML

