

Order No.: 5NY513724008 | **GTIN (EAN):** 4058352174982

Product description: mast,NEV2,con.rd,alu,coat,DB702S,4m,Ø76



mast, mast, conical round, of aluminium, coated, Siteco® metallic grey (DB 702S), height: 4.0m, spigot size: 76mm (post-top), planted section: h= 800mm / Ø= 140mm, standard: DIN EN 40, packaging unit: 1 piece

Wt. (kg): 21.3
 GTIN (EAN): 4058352174982

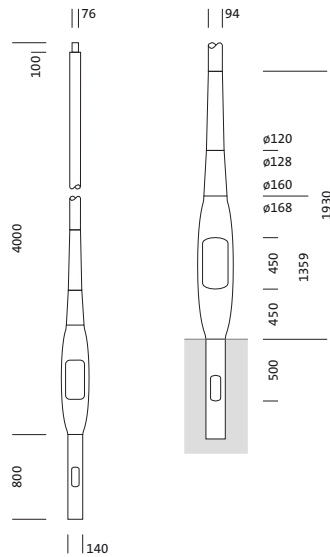

It is mandatory that the assembly instructions must be observed when planning and installing the electrical installation (to be found at www.siteco.com)
 Tolerances related to thermal, electrical and photometric data according to IEC 62722
 Issued 22.12.2023 - Modifications and errors subject to change - Ensure that you always use the latest version -

Order No.: 5NY513724008 | GTIN (EAN): 4058352174982

Detailed technical description: mast,NEV2,con.rd,alu,coat,DB702S,4m,Ø76



Key data

- Product type: mast
- Product name: mast
- Order No.: 5NY513724008

Certificates, Standards

- Standard: DIN EN 40

Material, Colour

- mast: aluminium, coated, Siteco® metallic grey (DB 702S), conical round, with offset spigot
- Colour specification: Siteco® metallic grey (DB 702S)

Dimensions, Weight

- Height: 4.0m
- Weight: 21.3kg
- Mast spigot: spigot size: 76mm
- Planted section: h= 800mm / Ø= 140mm

Order No.: 5NY513724008 | GTIN (EAN): 4058352174982

Dimensions: mast,NEV2,con.rd,alu,coat,DB702S,4m,Ø76

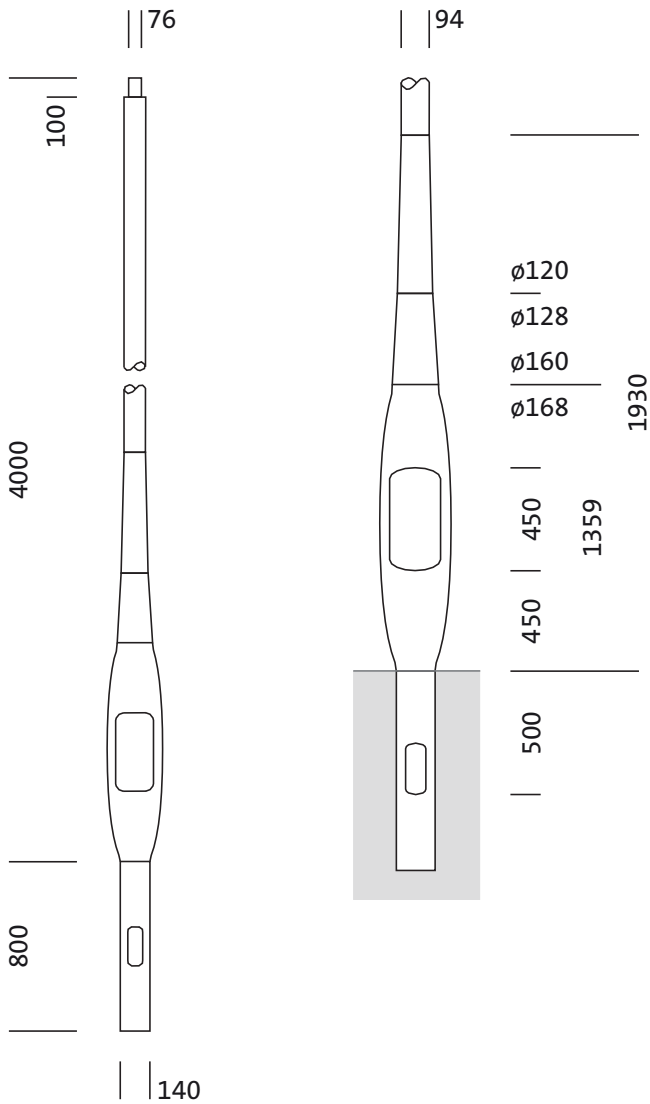

It is mandatory that the assembly instructions must be observed when planning and installing the electrical installation (to be found at www.siteco.com)

Tolerances related to thermal, electrical and photometric data according to IEC 62722

Issued 22.12.2023 - Modifications and errors subject to change - Ensure that you always use the latest version -