

**Order No.:** 58DV003 | **GTIN (EAN):** 4058352534304

**Product description:** Lun41,L83,IP20,wh

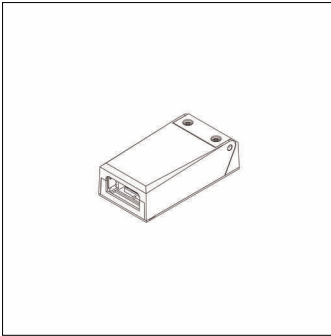

Lunis 41, junction box, through-wiring box,with terminal, 3-pole, of PC, white, length: 83mm, width: 42mm, height: 118mm, protection rating (complete): IP20, packaging unit: 1 piece

IP 20

Wt. (kg): 0.1  
GTIN (EAN): 4058352534304

Order No.: 58DV003 | GTIN (EAN): 4058352534304

Detailed technical description: Lun41,L83,IP20,wh

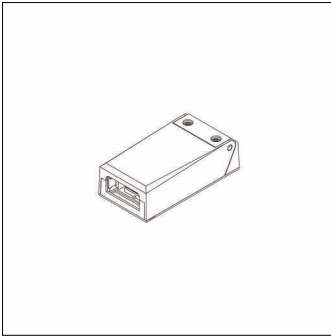

#### Key data

- Product type: junction box
- Product name: Lunis 41
- Order No.: 58DV003

#### Certificates, Standards

- Protection rating: IP20

#### Electrical connection

- Connection: terminal, 3-pole

#### Dimensions, Weight

- Length: 83mm
- Width: 42mm
- Height: 118mm
- Weight: 0.1kg