

Order No.: 5XE2F33S08HB | GTIN (EAN): 4058352725726

Product description: SL21mn,PCL,8240lm730,D4i,Sla



Streetlight SL 21 mini, mast luminaire, primary light control with lens, of PMMA, primary optical cover: cover, of toughened safety glass, transparent, light distribution: PC-L, light emission: direct distribution, primary light characteristic: asymmetric, left, installation type: side-entry, post-top, LED, High Power LED, rated luminous flux: 8.240lm, luminous efficacy: 125lm/W, light colour: 730, colour temperature: 3000K, control: overheat protection, constant luminous flux control, time-dependent luminous flux control, flexible luminous flux parameterisation, presetting dimming logarithmic, mains connection: 220..240V, AC, 50/60Hz, start of lifetime: 66W, end of service life: 69W, reduction: 30W, luminaire housing, of diecast aluminium, powder-coated, Siteco® metallic grey (DB 702S), corrosivity category C5 mid according to DIN EN ISO 12944, please order mast flange separately, inclination adjustable: 0°, 5°, 10°, 15°, sealing non-destructively replaceable, multi-level sealing system, length: 628mm, width: 235mm, height: 110mm, mast flange for spigot size: 42mm (side-entry): 5XC10008XM4, 60/48mm (side-entry/post-top): 5XC10108XM2, 76/60mm (side-entry/post-top): 5XC10108XM1, Smart Interface above, protection rating (complete): IP66, insulation class (complete): insulation class II (safety insulation), certification: CE, ENEC, ENEC+, VDE, impact resistance: IK09, permissible operating ambient temperature for outdoor applications: -40..+50°C, standard-compliant lighting for roads and squares, packaging unit: 1 piece



Lamps:	LED
Wt. (kg):	5.5
GTIN (EAN):	4058352725726



It is mandatory that the assembly instructions must be observed when planning and installing the electrical installation (to be found at www.siteco.com)

Tolerances related to thermal, electrical and photometric data according to IEC 62722

Issued 27.04.2024 - Modifications and errors subject to change - Ensure that you always use the latest version -

Order No.: 5XE2F33S08HB | **GTIN (EAN):** 4058352725726

Detailed technical description: SL21mn,PCL,8240lm730,D4i,SlA



Key data

- Product type: mast luminaire
- Product name: Streetlight SL 21 mini
- Order No.: 5XE2F33S08HB

Lighting technology | Lamps | Control gear

Component 1

Lighting technology:

- Light control: lens of PMMA
- Cover: cover, transparent
- Light distribution: PC-L
- Beam angle: wide distribution
- Symmetry: asymmetric, left
- Light emission: direct distribution

Lamps:

- Lamps: with High Power LED, LED
- Rated luminous flux: 8240lm
- Luminous efficacy: 125lm/W
- Colour temperature: 3000K
- Colour rendering index: CRI > 70
- Light colour: 730
- Rated input power begin service life: 66
- Rated input power end service life: 69
- Rated input power at 50% lumin. flux: 30

Operating device:

- Control: D4i, Smart Interface above
- Equipment: overheat protection, constant luminous flux control, time-dependent luminous flux control, flexible luminous flux parameterisation, presetting dimming logarithmic

Certificates, Standards

- Protection rating: IP66
- Insulation class: insulation class II (safety insulation)
- Impact resistance: IK09
- Temperature range (operation): -40..+50°C
- Supplement: standard-compliant lighting for roads and squares
- Corrosion protection: corrosivity category C5 mid according to DIN EN ISO 12944
- Certification, designation: CE, ENEC, ENEC+, VDE

Material, Colour

- luminaire housing: diecast aluminium, powder-coated, Siteco® metallic grey (DB 702S), please order mast flange separately, inclination adjustable: 0°, 5°, 10°, 15°, sealing non-destructively replaceable, multi-level sealing system
- Colour specification: Siteco® metallic grey (DB 702S)
- Cover: cover of toughened safety glass

Mounting

- Mounting method, mounting location: side-entry, post-top, on mast

Electrical connection

- Nominal voltage: 220..240V, 50/60Hz, AC
- Surge voltage resistance: 10kV 1.2/50µs

Dimensions, Weight

- Length: 628mm
- Width: 235mm
- Height: 110mm
- Weight: 5.5kg
- Mast spigot: mast flange for spigot size: 42mm (side-entry): 5XC10008XM4, 60/48mm (side-entry/post-top): 5XC10108XM2, 76/60mm (side-entry/post-top): 5XC10108XM1

Light emission

- Light emission: 0% at 0° inclination

Service life

- Rated service life: 100000h (L96/B10) at AT = 25°C

Order No.: 5XE2F33S08HB | GTIN (EAN): 4058352725726

Dimensions: SL21mn,PCL,8240lm730,D4i,Sla

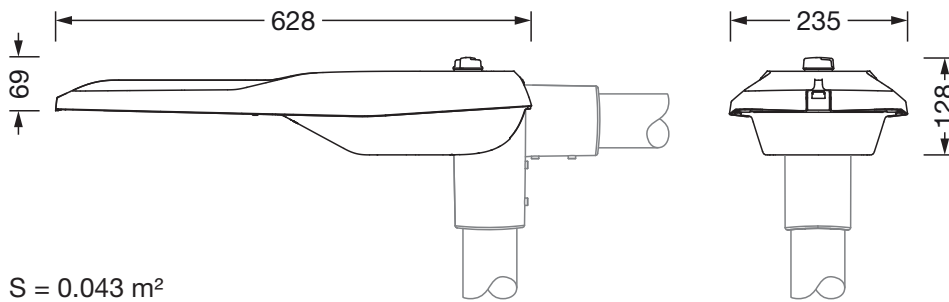

S = 0.043 m²

It is mandatory that the assembly instructions must be observed when planning and installing the electrical installation (to be found at www.siteco.com)

Tolerances related to thermal, electrical and photometric data according to IEC 62722

Issued 27.04.2024 - Modifications and errors subject to change - Ensure that you always use the latest version -