

Order No.: 5XE2C43S08GB | GTIN (EAN): 4058352725023

Product description: SL21mn,ST0.8a,6180lm740,D4i,Sla



Streetlight SL 21 mini, mast luminaire, primary light control with lens, of PMMA, primary optical cover: cover, of toughened safety glass, transparent, light distribution: ST0.8a, light emission: direct distribution, primary light characteristic: asymmetric, installation type: side-entry, post-top, LED, High Power LED, rated luminous flux: 6.180lm, luminous efficacy: 153lm/W, light colour: 740, colour temperature: 4000K, control: overheat protection, constant luminous flux control, time-dependent luminous flux control, flexible luminous flux parameterisation, presetting dimming logarithmic, mains connection: 220..240V, AC, 50/60Hz, start of lifetime: 40W, end of service life: 41W, reduction: 19W, luminaire housing, of diecast aluminium, powder-coated, Siteco® metallic grey (DB 702S), corrosivity category C5 mid according to DIN EN ISO 12944, please order mast flange separately, inclination adjustable: 0°, 5°, 10°, 15°, sealing non-destructively replaceable, multi-level sealing system, length: 628mm, width: 235mm, height: 110mm, mast flange for spigot size: 42mm (side-entry): 5XC10008XM4, 60/48mm (side-entry/post-top): 5XC10108XM2, 76/60mm (side-entry/post-top): 5XC10108XM1, Smart Interface above, protection rating (complete): IP66, insulation class (complete): insulation class II (safety insulation), certification: CE, ENEC, ENEC+, VDE, impact resistance: IK09, permissible operating ambient temperature for outdoor applications: -40..+50°C, standard-compliant lighting for roads and squares, packaging unit: 1 piece



Lamps: LED  
 Wt. (kg): 5.0  
 GTIN (EAN): 4058352725023

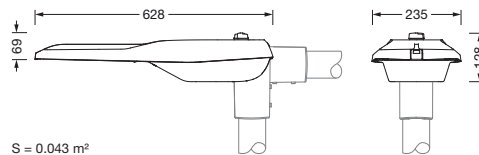

**Order No.:** 5XE2C43S08GB | **GTIN (EAN):** 4058352725023

**Detailed technical description:** SL21mn,ST0.8a,6180lm740,D4i,SlA



### Key data

- Product type: mast luminaire
- Product name: Streetlight SL 21 mini
- Order No.: 5XE2C43S08GB

### Lighting technology | Lamps | Control gear

#### Component 1

#### Lighting technology:

- Light control: lens of PMMA
- Cover: cover, transparent
- Light distribution: ST0.8a
- Beam angle: wide distribution
- Symmetry: asymmetric distribution
- Light emission: direct distribution

#### Lamps:

- Lamps: with High Power LED, LED
- Rated luminous flux: 6180lm
- Luminous efficacy: 153lm/W
- Colour temperature: 4000K
- Colour rendering index: CRI > 70
- Light colour: 740
- Rated input power begin service life: 40
- Rated input power end service life: 41
- Rated input power at 50% lumin. flux: 19

#### Operating device:

- Control: D4i, Smart Interface above
- Equipment: overheat protection, constant luminous flux control, time-dependent luminous flux control, flexible luminous flux parameterisation, presetting dimming logarithmic

#### Certificates, Standards

- Protection rating: IP66
- Insulation class: insulation class II (safety insulation)
- Impact resistance: IK09
- Temperature range (operation): -40..+50°C
- Supplement: standard-compliant lighting for roads and squares
- Corrosion protection: corrosivity category C5 mid according to DIN EN ISO 12944
- Certification, designation: CE, ENEC, ENEC+, VDE

### Material, Colour

- luminaire housing: diecast aluminium, powder-coated, Siteco® metallic grey (DB 702S), please order mast flange separately, inclination adjustable: 0°, 5°, 10°, 15°, sealing non-destructively replaceable, multi-level sealing system
- Colour specification: Siteco® metallic grey (DB 702S)
- Cover: cover of toughened safety glass

### Mounting

- Mounting method, mounting location: side-entry, post-top, on mast

### Electrical connection

- Nominal voltage: 220..240V, 50/60Hz, AC
- Surge voltage resistance: 10kV 1.2/50µs

### Dimensions, Weight

- Length: 628mm
- Width: 235mm
- Height: 110mm
- Weight: 5.0kg
- Mast spigot: mast flange for spigot size: 42mm (side-entry): 5XC10008XM4, 60/48mm (side-entry/post-top): 5XC10108XM2, 76/60mm (side-entry/post-top): 5XC10108XM1

### Light emission

- Light emission: 0% at 0° inclination

### Service life

- Rated service life: 100000h (L96/B10) at AT = 25°C

Order No.: 5XE2C43S08GB | GTIN (EAN): 4058352725023

Dimensions: SL21mn,ST0.8a,6180lm740,D4i,SlA

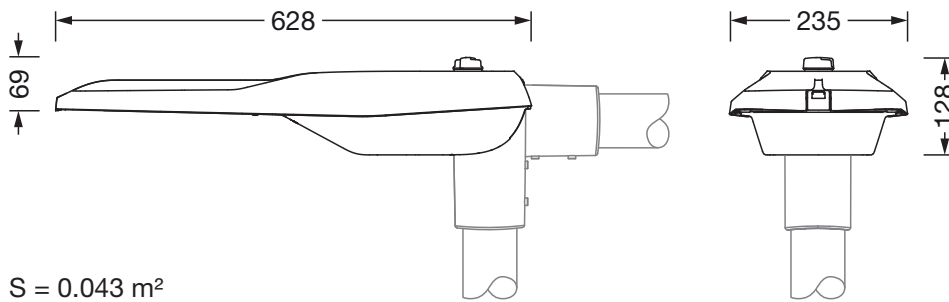

S = 0.043 m<sup>2</sup>

It is mandatory that the assembly instructions must be observed when planning and installing the electrical installation (to be found at [www.siteco.com](http://www.siteco.com))

Tolerances related to thermal, electrical and photometric data according to IEC 62722

Issued 27.04.2024 - Modifications and errors subject to change - Ensure that you always use the latest version -