

Order No.: 5WD36CDE3SN3 | **GTIN (EAN):** 4058352392690

Product description: TL33Smd,46300lm750,DA,TSG



TL 33S midi, tunnel luminaire, primary optical cover: cover panel, of toughened safety glass, non-reflecting, transparent, light emission: direct distribution, primary light characteristic: symmetric, installation type: surface-mounted, connection on control gear side, LED, High Power LED, rated luminous flux: 46.300lm, luminous efficacy: 161lm/W, light colour: 750, colour temperature: 5000K, control gear: ECG DALI, with system connector, mains connection: 220..240V, AC, 50/60Hz, connection cable plug integrated into luminaire housing at face end, rated input power: 287W, connection on mains side, 7-pole, max. 10mm² (5G+2), with terminal, luminaire housing, of stainless steel 1.4404 (AISI316), etched and passivated, length: 960mm, width: 295mm, height: 68mm, heat sink, of Al Mg 2, e-box, of stainless steel 1.4404 (AISI316), etched and passivated, length: 510mm, width: 213mm, height: 115mm, protection rating (complete): IP66, insulation class (complete): insulation class I (protective earthing), certification: CE, impact resistance: IK09, permissible operating ambient temperature: -25..+45°C, packaging unit: 1 piece

IP 66 IK 09  

Lamps: LED
 Wt. (kg): 17.6
 GTIN (EAN): 4058352392690



It is mandatory that the assembly instructions must be observed when planning and installing the electrical installation (to be found at www.siteco.com)

Tolerances related to thermal, electrical and photometric data according to IEC 62722

Issued 24.02.2023 - Modifications and errors subject to change - Ensure that you always use the latest version -

Order No.: 5WD36CDE3SN3 | **GTIN (EAN):** 4058352392690

Detailed technical description: TL33Smd,46300lm750,DA,TSG



Key data

- Product type: tunnel luminaire
- Product name: TL 33S midi
- Order No.: 5WD36CDE3SN3

Lighting technology | Lamps | Control gear

Component 1

Lighting technology:

- Cover: cover panel, transparent, non-reflecting
- Symmetry: symmetric distribution
- Light emission: direct distribution

Lamps:

- Supplement: suitable for 3-phase through-wiring on mains side

Operating device:

- Control gear: ECG DALI
- Control: DALI

Component 2

Certificates, Standards

- Protection rating: IP66
- Insulation class: insulation class I (protective earthing)
- Impact resistance: IK09
- Temperature range (operation): -25..+45°C
- Certification, designation: CE

Material, Colour

- luminaire housing: stainless steel 1.4404 (AISI316), etched and passivated
- e-box: stainless steel 1.4404 (AISI316), etched and passivated
- Cover: cover panel of toughened safety glass

Mounting

- Mounting method, mounting location: surface-mounted, to supporting structure, to the ceiling

Electrical connection

- Connection: system connector
- Nominal voltage: 220..240V, 50/60Hz, AC
- Surge voltage resistance: 10kV 1.2/50µs
- Connection cable: plug integrated into luminaire housing at face end

Dimensions, Weight

- Length: 960mm
- Width: 295mm
- Height: 68mm
- Weight: 17.6kg

Service life

- Rated service life: 100000h (L95/B10) at AT = 25°C

Order No.: 5WD36CDE3SN3 | GTIN (EAN): 4058352392690

Dimensions: TL33Smd,46300lm750,DA,TSG

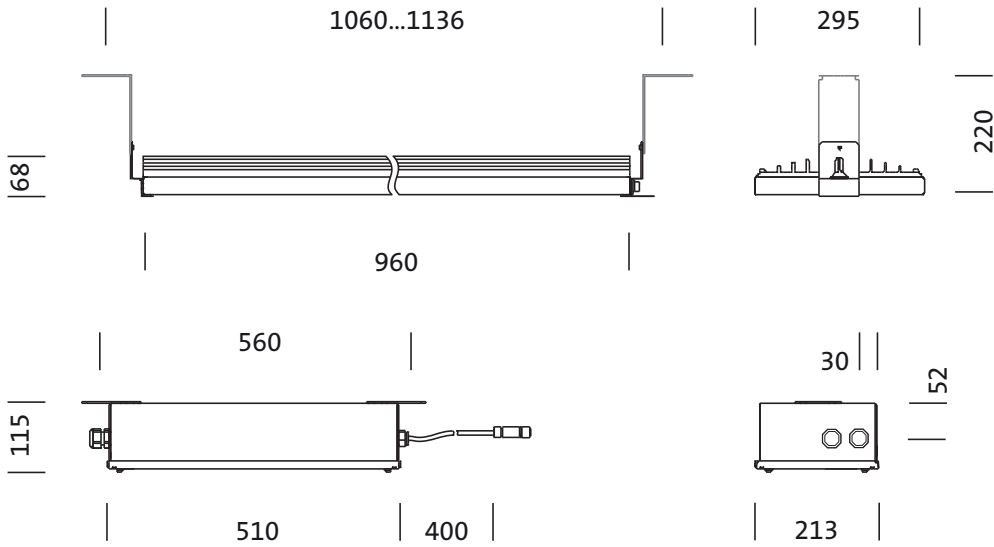

It is mandatory that the assembly instructions must be observed when planning and installing the electrical installation (to be found at www.siteco.com)

Tolerances related to thermal, electrical and photometric data according to IEC 62722

Issued 24.02.2023 - Modifications and errors subject to change - Ensure that you always use the latest version -

Order No.: 5WD36CDE3SN3 | GTIN (EAN): 4058352392690

Planning data: TL33Smd,46300lm750,DA,TSG

5WD36CDE3SN3: 1x LED

4058352392690

5WD36CDE3SN3

LED 5000 K | CRI \geq 70 ϕ_N 46300 lm

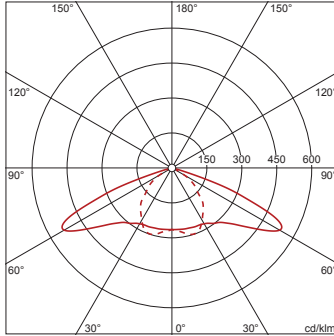

— C 0/180 - - - C 90/270

It is mandatory that the assembly instructions must be observed when planning and installing the electrical installation (to be found at www.siteco.com)

Tolerances related to thermal, electrical and photometric data according to IEC 62722

Issued 24.02.2023 - Modifications and errors subject to change - Ensure that you always use the latest version -