

**Order No.:** 59MQ17005021 | **GTIN (EAN):** 4058352465370

**Product description:** Apol-,f.lum.1545x310

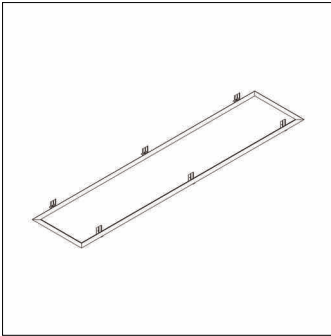

Apollon®, ceiling recessing frame, installation type: recessed, mounting frame, of sheet steel, white, length: 1.589mm, width: 352mm, packaging unit: 1 piece

Wt. (kg): 1.0  
GTIN (EAN): 4058352465370

Order No.: 59MQ17005021 | GTIN (EAN): 4058352465370

Detailed technical description: Apol-,f.lum.1545x310

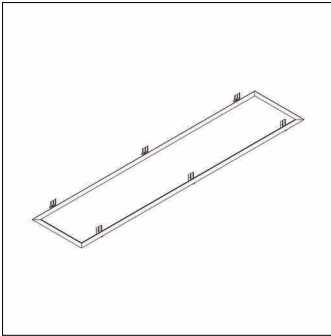

#### Key data

- Product type: ceiling recessing frame
- Product name: Apollon®
- Order No.: 59MQ17005021

#### Material, Colour

- mounting frame: sheet steel, white
- Colour specification: white

#### Mounting

- Mounting method, mounting location: recessed, in the ceiling
- Supplement: for luminaire Lx B= 1545 x 310mm

#### Dimensions, Weight

- Length: 1589mm
- Width: 352mm
- Weight: 1.0kg