

Order No.: 59MQ15005021 | **GTIN (EAN):** 4058352465356

Product description: Apol-,f.lum.1245x181

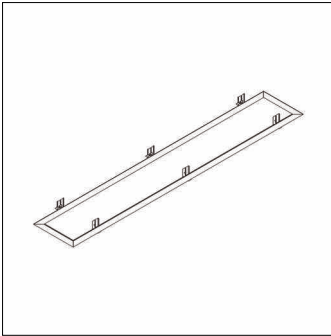

Apollon®, ceiling recessing frame, installation type: recessed, mounting frame, of sheet steel, white, length: 1.289mm, width: 223mm, packaging unit: 1 piece

Wt. (kg): 0.8
GTIN (EAN): 4058352465356

Order No.: 59MQ15005021 | GTIN (EAN): 4058352465356

Detailed technical description: Apol-,f.lum.1245x181

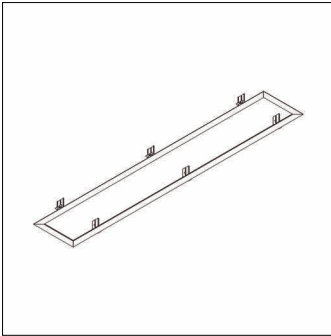

Key data

- Product type: ceiling recessing frame
- Product name: Apollon®
- Order No.: 59MQ15005021

Material, Colour

- mounting frame: sheet steel, white
- Colour specification: white

Mounting

- Mounting method, mounting location: recessed, in the ceiling
- Supplement: for luminaire Lx B= 1245 x 181mm

Dimensions, Weight

- Length: 1289mm
- Width: 223mm
- Weight: 0.8kg