

Order No.: 51DB15DF42 | **GTIN (EAN):** 4058352555095

Product description: Lun21XL,Ø200,2280lm840,DA2wh



Lunis 21, XL, downlight, of PC, light emission: direct distribution, LED rated luminous flux: 2.280lm, light colour: 840, control gear: ECG DALI, with terminal, 5-pole, mains connection: 220..240V, AC, housing, round, of diecast aluminium, traffic white (RAL 9016), diameter: 213mm, protection rating (complete): IP20, protection rating (on room side): IP54, insulation class (complete): insulation class II (safety insulation), certification: CE, impact resistance: IK02, packaging unit: 1 piece

IP 20  

Lamps:	LED
Wt. (kg):	1.0
GTIN (EAN):	4058352555095



It is mandatory that the assembly instructions must be observed when planning and installing the electrical installation (to be found at www.siteco.com)

Tolerances related to thermal, electrical and photometric data according to IEC 62722

Issued 15.03.2024 - Modifications and errors subject to change - Ensure that you always use the latest version -

Order No.: 51DB15DF42 | GTIN (EAN): 4058352555095

Detailed technical description: Lun21XL,Ø200,2280lm840,DA2wh



Key data

- Product type: downlight
- Product name: Lunis 21 XL
- Order No.: 51DB15DF42

Lighting technology | Lamps | Control gear

Component 1

Lighting technology:

- Beam angle: wide distribution
- Light emission: direct distribution
- UGR viewing direction along longitudinal luminaire axis: ≤ 19
- UGR viewing direction along lateral luminaire axis: ≤ 19

Lamps:

- Lamps: with LED
- Rated luminous flux: 2280lm
- Luminous efficacy: 129lm/W
- Colour temperature: 4000K
- Colour rendering index: CRI > 80
- Light colour: 840
- SDCM (Standard Deviation of Colour Matching): MacAdam ≤ 3 SDCM (initial)
- Rated input power: 18W
- Supplement: halogen-free wiring

Operating device:

- Control gear: ECG DALI
- Control: DALI 2

Certificates, Standards

- Protection rating: IP20
- Protection rating (on room side): IP54
- Insulation class: insulation class II (safety insulation)
- Impact resistance: IK02
- Certification, designation: CE

Material, Colour

- housing: diecast aluminium, traffic white (RAL 9016), round
- Colour specification: traffic white (RAL 9016)

Mounting

- Mounting method, mounting location: recessed, in the ceiling
- \varnothing of ceiling cut-out: 200mm
- Arrangement: single arrangement

Electrical connection

- Connection: terminal, 5-pole
- Nominal voltage: 220..240V, AC

Dimensions, Weight

- Diameter: 213mm
- Height: 66mm
- Weight: 1.0kg

Service life

- Rated service life: 50000h (L80/B50) at AT = 25°C

Order No.: 51DB15DF42 | GTIN (EAN): 4058352555095

Dimensions: Lun21XL,Ø200,2280lm840,DA2wh

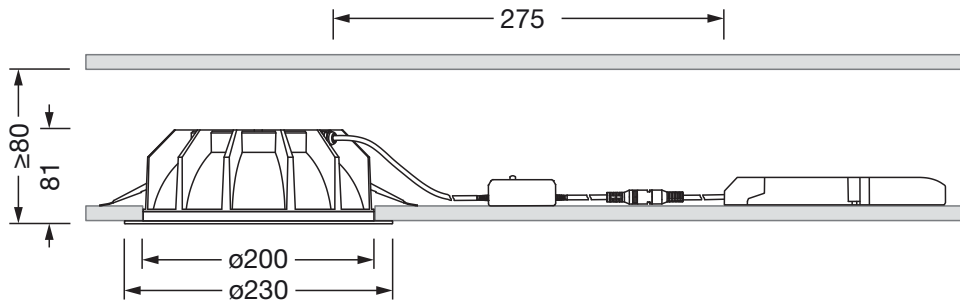

It is mandatory that the assembly instructions must be observed when planning and installing the electrical installation (to be found at www.siteco.com)

Tolerances related to thermal, electrical and photometric data according to IEC 62722

Issued 15.03.2024 - Modifications and errors subject to change - Ensure that you always use the latest version -