

Order No.: 5XA8581B1121 | GTIN (EAN): 4058352718414

Product description: FL41md,A320003,26000lm730,ML



Floodlight FL 41 midi, floodlight, primary light control with lens, of PMMA, primary optical cover: protective disc, transparent, light distribution: A320003, light emission: direct distribution, installation type: surface-mounted, lamps: LED, rated values: 26.000lm | 200W | 130lm/W, colour temperature: 3000K, colour rendering: CRI > 70, light colour: 730, light setting 1 (further light settings possible): 100% | 26.000lm | 200W | 130lm/W | 3.000K control gear: ON/OFF Multilumen, mains connection: 220..240V, AC, 50/60Hz, luminaire housing, of diecast aluminium, powder-coated, metallic grey (RAL 9006), length: 375mm, width: 335mm, height: 65mm, protection rating (complete): IP65, insulation class (complete): insulation class I (protective earthing), certification: CE, ENEC, impact resistance: IK08, permissible operating ambient temperature: -40..+40°C, permissible storage temperature: -40..+60°C, packaging unit: 1 piece



Lamps:	LED
Wt. (kg):	3.7
GTIN (EAN):	4058352718414

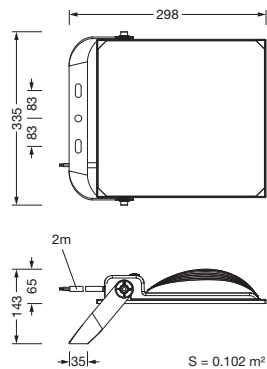

It is mandatory that the assembly instructions must be observed when planning and installing the electrical installation (to be found at www.siteco.com)

Tolerances related to thermal, electrical and photometric data according to IEC 62722

Issued 27.03.2026 - Modifications and errors subject to change - Ensure that you always use the latest version -

Order No.: 5XA8581B1121 | GTIN (EAN): 4058352718414

Detailed technical description: FL41md,A320003,26000lm730,ML



Key data

- Product type: floodlight
- Product name: Floodlight FL 41 midi
- Order No.: 5XA8581B1121

Lighting technology | Lamps | Control gear

Component 1

Lighting technology:

- Light control: lens of PMMA
- Cover: protective disc, transparent
- Light distribution: PL32
- Light emission: direct distribution

Lamps:

- Lamps: with High Power LED, LED
- Rated luminous flux: 26000lm
- Luminous efficacy: 130lm/W
- Colour temperature: 3000K
- Colour rendering index: CRI > 70
- Light colour: 730
- SDCM (Standard Deviation of Colour Matching): MacAdam \leq 7 SDCM (initial)
- Rated input power: 200W
- Supplement: luminous flux adjustable on luminaire in four steps (13000/19500/22100/26000lm), connected load according to luminous flux setting (100/150/170/200W)

Operating device:

- Control: ON/OFF Multilumen

Certificates, Standards

- Protection rating: IP65
- Insulation class: insulation class I (protective earthing)
- Impact resistance: IK08
- Temperature range (operation): -40..+40°C
- Certification, designation: CE, ENEC

Material, Colour

- luminaire housing: diecast aluminium, powder-coated, metallic grey (RAL 9006)
- Cover: protective disc

Mounting

- Mounting method, mounting location: surface-mounted
- Arrangement: single arrangement
- Supplement: with mounting bracket

Electrical connection

- Connection: cable, 3x 1.5mm²
- Nominal voltage: 220..240V, 50/60Hz, AC
- Connection cable: pre-assembled, L= 2m

Dimensions, Weight

- Length: 375mm
- Width: 335mm
- Height: 65mm
- Weight: 3.7kg

Service life

- Rated service life: 50000h (L80/B50) at AT = 25°C

Order No.: 5XA8581B1121 | GTIN (EAN): 4058352718414

Dimensions: FL41md,A320003,26000lm730,ML

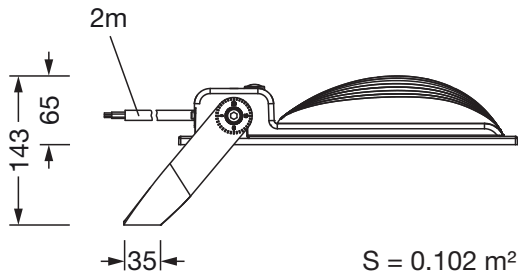
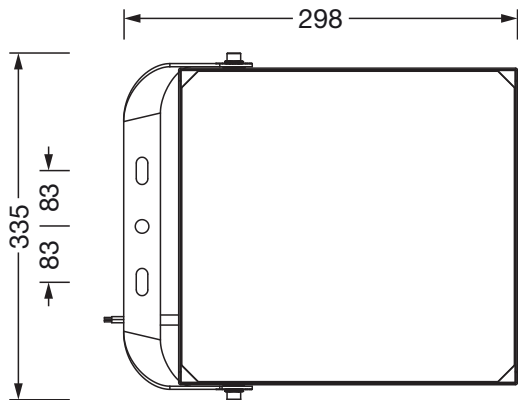

It is mandatory that the assembly instructions must be observed when planning and installing the electrical installation (to be found at www.siteco.com)

Tolerances related to thermal, electrical and photometric data according to IEC 62722

Issued 27.03.2026 - Modifications and errors subject to change - Ensure that you always use the latest version -