

Order No.: 5PJA012001A | **GTIN (EAN):** 4058352955093

Product description: Round31B,1800lm830,DA2,Ø290

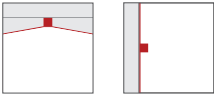

Round 31 B, wall and ceiling luminaire, primary optical cover: enclosure, of PMMA, light emission: direct distribution, primary light characteristic: symmetric, installation type: surface-mounted, LED, rated luminous flux: 1.800lm, luminous efficacy: 120lm/W, light colour: 830, colour temperature: 3000K, with terminal, 3+2-pole, max. 2.5mm², mains connection: 230V, AC, 50/60Hz, rated input power: 15W, luminaire housing, round, of steel, white, diameter: 290mm, height: 85mm, protection rating (complete): IP40, insulation class (complete): insulation class I (protective earthing), certification: CE, impact resistance: IK02, permissible operating ambient temperature: -20..+25°C, packaging unit: 1 piece

IP 40  

Lamps:	LED
Wt. (kg):	0.8
GTIN (EAN):	4058352955093

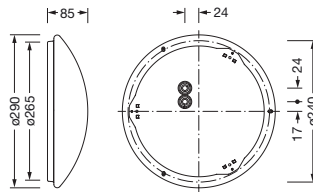

Order No.: 5PJA012001A | GTIN (EAN): 4058352955093

Detailed technical description: Round31B,1800lm830,DA2,Ø290



Key data

- Product type: wall and ceiling luminaire
- Product name: Round 31 B
- Order No.: 5PJA012001A

Dimensions, Weight

- Diameter: 290mm
- Height: 85mm
- Weight: 0.8kg

Lighting technology | Lamps | Control gear

Service life

- Rated service life: 50000h (L80/B10) at AT = 25°C

Component 1

Lighting technology:

- Cover: enclosure
- Beam angle: 120°
- Symmetry: symmetric distribution
- Light emission: direct distribution

Lamps:

- Lamps: with LED
- Rated luminous flux: 1800lm
- Luminous efficacy: 120lm/W
- Colour temperature: 3000K
- Colour rendering index: CRI > 80
- Light colour: 830
- SDCM (Standard Deviation of Colour Matching): MacAdam ≤ 3 SDCM (initial)
- Rated input power: 15W

Operating device:

- Control: DALI 2

Certificates, Standards

- Protection rating: IP40
- Insulation class: insulation class I (protective earthing)
- Impact resistance: IK02
- Temperature range (operation): -20...+25°C
- Certification, designation: CE

Material, Colour

- luminaire housing: steel, white, round
- Colour specification: white
- Cover: enclosure of PMMA

Mounting

- Mounting method, mounting location: surface-mounted, to the ceiling, to the wall
- Arrangement: single arrangement

Electrical connection

- Connection: terminal, 3+2-pole, max. 2.5mm²
- Nominal voltage: 230V, 50/60Hz, AC

Order No.: 5PJA012001A | GTIN (EAN): 4058352955093

Dimensions: Round31B,1800lm830,DA2,Ø290

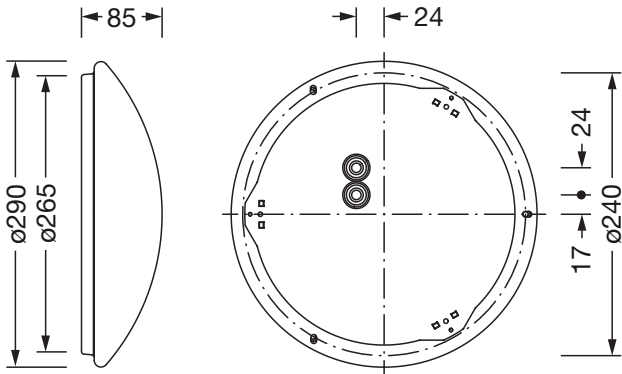

It is mandatory that the assembly instructions must be observed when planning and installing the electrical installation (to be found at www.siteco.com)
Tolerances related to thermal, electrical and photometric data according to IEC 62722
Issued 26.01.2024 - Modifications and errors subject to change - Ensure that you always use the latest version -