

Order No.: 5PJBI1D3104A | **GTIN (EAN):** 4058352960257

Product description: Sil21Ring-I,3510lm840,DA2,610,bk



Silica® 21 Ring-I, suspended luminaire, of PMMA, frosted, light emission: inner ring side luminous distribution, primary light characteristic: symmetric, installation type: suspended mounting, LED, rated luminous flux: 3.510lm, luminous efficacy: 59lm/W, light colour: 840, colour temperature: 4000K, with terminal, 5-pole, mains connection: 230V, AC/DC, 0/50..60Hz, rated input power: 60W, housing, of extruded aluminium section, jet black (RAL 9005), diameter: 610mm, ceiling canopy, jet black (RAL 9005), protection rating (lamp compartment): IP40, insulation class (complete): insulation class I (protective earthing), certification: CE, impact resistance: IK02, permissible operating ambient temperature: 0..+35°C, packaging unit: 1 piece



Lamps:	LED
Wt. (kg):	2.2
GTIN (EAN):	4058352960257

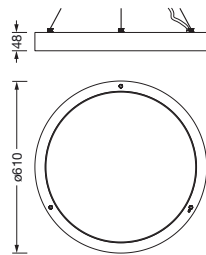

It is mandatory that the assembly instructions must be observed when planning and installing the electrical installation (to be found at www.siteco.com)

Tolerances related to thermal, electrical and photometric data according to IEC 62722

Issued 13.10.2023 - Modifications and errors subject to change - Ensure that you always use the latest version -

Order No.: 5PJBI1D3104A | GTIN (EAN): 4058352960257

Detailed technical description: Sil21Ring-I,3510lm840,DA2,610,bk



Key data

- Product type: suspended luminaire
- Product name: Silica® 21 Ring-I
- Order No.: 5PJBI1D3104A

Lighting technology | Lamps | Control gear

Component 1

Lighting technology:

- Beam angle: wide distribution
- Symmetry: symmetric
- Light emission: inner ring side luminous

Lamps:

- Lamps: with LED
- Rated luminous flux: 3510lm
- Luminous efficacy: 59lm/W
- Colour temperature: 4000K
- Colour rendering index: CRI > 80
- Light colour: 840
- SDCM (Standard Deviation of Colour Matching): MacAdam ≤ 3 SDCM (initial)
- Rated input power: 60W

Operating device:

- Control: DALI 2

Certificates, Standards

- Protection rating (lamp compartment): IP40
- Insulation class: insulation class I (protective earthing)
- Impact resistance: IK02
- Temperature range (operation): 0..+35°C
- Certification, designation: CE

Material, Colour

- housing: extruded aluminium section, jet black (RAL 9005)
- Colour specification: jet black (RAL 9005)
- Colour specification: jet black (RAL 9005)

Mounting

- Mounting method, mounting location: suspended mounting
- Recommended suspension height: up to 4.0m
- Arrangement: single arrangement

Electrical connection

- Connection: terminal, 5-pole
- Nominal voltage: 230V, 0/50..60Hz, AC/DC

Dimensions, Weight

- Diameter: 610mm
- Weight: 2.2kg

Service life

- Rated service life: 50000h (L80/B50) at AT = 25°C

Order No.: 5PJBI1D3104A | GTIN (EAN): 4058352960257

Dimensions: Sil21Ring-I,3510lm840,DA2,610,bk

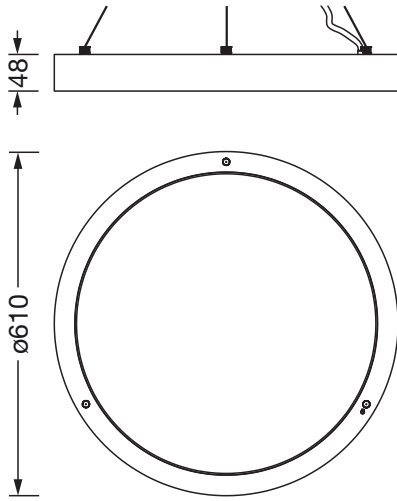

It is mandatory that the assembly instructions must be observed when planning and installing the electrical installation (to be found at www.siteco.com)

Tolerances related to thermal, electrical and photometric data according to IEC 62722

Issued 13.10.2023 - Modifications and errors subject to change - Ensure that you always use the latest version -