

Order No.: 5XE6D27N08HB | GTIN (EAN): 4058352897447

Product description: SL21mn,ST1.0a,7490lm722,NEMA7



Streetlight SL 21 mini, mast luminaire, primary light control with lens, of PMMA, primary optical cover: cover, of toughened safety glass, transparent, light distribution: ST1.0a, light emission: direct distribution, primary light characteristic: asymmetric, installation type: side-entry, LED, 3G 1.5mm², High Power LED, rated luminous flux: 7.490lm, luminous efficacy: 114lm/W, light colour: 722, colour temperature: 2200K, control: overheat protection, presetting dimming linear, constant luminous flux control, time-dependent luminous flux control, flexible luminous flux parameterisation, mains connection: 230..240V, AC, 50/60Hz, connection cable pre-assembled, cable length: 8,5m, wiring characteristics: H07RN-F, start of lifetime: 66W, end of service life: 69W, reduction: 30W, luminaire housing, of diecast aluminium (EN AC-44300), powder-coated, Siteco® metallic grey (DB 702S), corrosivity category C5 mid according to DIN EN ISO 12944, multi-level sealing system, sealing non-destructively replaceable, inclination adjustable: 0°, 5°, 10°, 15°, length: 628mm, width: 235mm, height: 110mm, spigot size: 42mm (side-entry), protection rating (complete): IP66, insulation class (complete): insulation class I (protective earthing), certification: CE, ENEC, ENEC+, VDE, impact resistance: IK09, permissible operating ambient temperature for outdoor applications: -40..+50°C, standard-compliant lighting for roads and squares, packaging unit: 1 piece



Lamps:	LED
Wt. (kg):	7.1
GTIN (EAN):	4058352897447

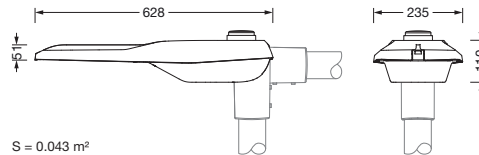

Order No.: 5XE6D27N08HB | GTIN (EAN): 4058352897447

Detailed technical description: SL21mn,ST1.0a,7490lm722,NEMA7



Key data

- Product type: mast luminaire
- Product name: Streetlight SL 21 mini
- Order No.: 5XE6D27N08HB

Lighting technology | Lamps | Control gear

Component 1

Lighting technology:

- Light control: lens of PMMA
- Cover: cover, transparent
- Light distribution: ST1.0a
- Beam angle: wide distribution
- Symmetry: asymmetric distribution
- Light emission: direct distribution

Lamps:

- Lamps: with High Power LED, LED
- Rated luminous flux: 7490lm
- Luminous efficacy: 114lm/W
- Colour temperature: 2200K
- Colour rendering index: CRI > 70
- Light colour: 722
- Rated input power begin service life: 66
- Rated input power end service life: 69
- Rated input power at 50% lumin. flux: 30

Operating device:

- Control: NEMA (7pin)
- Equipment: overheat protection, constant luminous flux control, time-dependent luminous flux control, flexible luminous flux parameterisation, presetting dimming linear

Certificates, Standards

- Protection rating: IP66
- Insulation class: insulation class I (protective earthing)
- Impact resistance: IK09
- Temperature range (operation): -40..+50°C
- Supplement: standard-compliant lighting for roads and squares
- Corrosion protection: corrosivity category C5 mid according to DIN EN ISO 12944
- Certification, designation: CE, ENEC, ENEC+, VDE

Material, Colour

- luminaire housing: diecast aluminium (EN AC-44300), powder-coated, Siteco® metallic grey (DB 702S), inclination adjustable: 0°, 5°, 10°, 15°, sealing non-destructively replaceable, multi-level sealing system
- Colour specification: Siteco® metallic grey (DB 702S)
- Cover: cover of toughened safety glass

Mounting

- Mounting method, mounting location: side-entry, on mast
- Supplement: with pre-assembled mast flange

Electrical connection

- Nominal voltage: 230..240V, 50/60Hz, AC
- Surge voltage resistance: 10kV 1.2/50µs
- Connection cable: pre-assembled, L= 8.5m

Dimensions, Weight

- Length: 628mm
- Width: 235mm
- Height: 110mm
- Weight: 7.1kg
- Mast spigot: spigot size: 42mm (side-entry)

Light emission

- Light emission: 0% at 0° inclination

Service life

- Rated service life: 100000h (L97/B10) at AT = 25°C

Order No.: 5XE6D27N08HB | GTIN (EAN): 4058352897447

Dimensions: SL21mn,ST1.0a,7490lm722,NEMA7

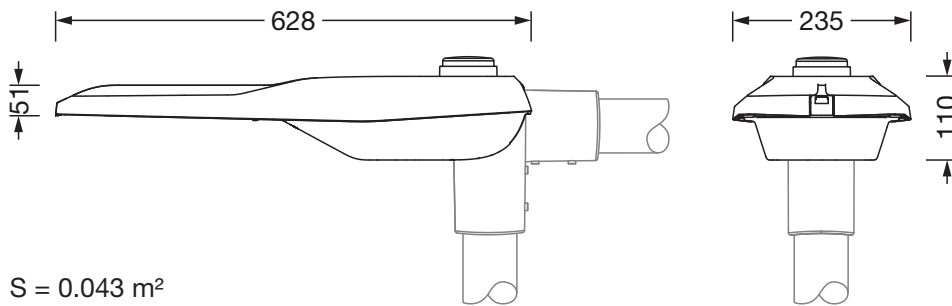

S = 0.043 m²