

Order No.: 51DC112DD4400A | **GTIN (EAN):** 4069025358981

Product description: Lun11R,surf,wh4800lm840,DA2



Lunis 11 R, downlight, light control with reflector, highly specular, light emission: direct distribution, rated luminous flux: 4.800lm, light colour: 840, with terminal, 3+2-pole, max. 2.5mm², mains connection: 230V, AC, 50/60Hz, luminaire housing, of aluminium, white, diameter: 380mm, protection rating (complete): IP20, insulation class (complete): insulation class I (protective earthing), certification: CE, permissible ambient temperature for indoor applications: ≤ +35°C, standard: EN 50419, packaging unit: 1 piece

IP 20  

Wt. (kg): 2.0
GTIN (EAN): 4069025358981

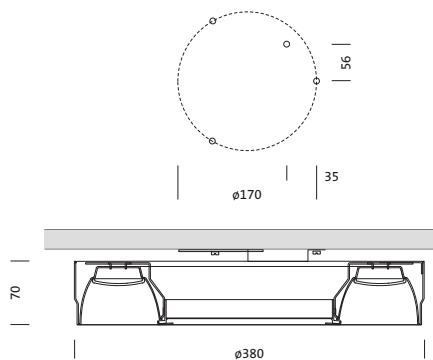

It is mandatory that the assembly instructions must be observed when planning and installing the electrical installation (to be found at www.siteco.com)

Tolerances related to thermal, electrical and photometric data according to IEC 62722

Issued 13.09.2025 - Modifications and errors subject to change - Ensure that you always use the latest version -

Order No.: 51DC112DD4400A | GTIN (EAN): 4069025358981

Detailed technical description: Lun11R,surf,wh4800lm840,DA2



Key data

- Product type: downlight
- Product name: Lunis 11 R
- Order No.: 51DC112DD4400A

Lighting technology | Lamps | Control gear

Component 1

Lighting technology:

- Light control: reflector, highly specular
- Beam angle: wide distribution
- Symmetry: symmetric distribution
- Light emission: direct distribution

Lamps:

- Rated luminous flux: 4800lm
- Luminous efficacy: 162lm/W
- Colour temperature: 4000K
- Colour rendering index: CRI > 80
- Light colour: 840
- Rated input power: 29.6W

Operating device:

- Control: DALI 2

Certificates, Standards

- Protection rating: IP20
- Insulation class: insulation class I (protective earthing)
- Temperature range (operation): $\leq +35^{\circ}\text{C}$
- Standard: EN 50419
- Certification, designation: CE

Material, Colour

- luminaire housing: aluminium, white
- Quantity: 1 piece
- Colour specification: white

Mounting

- Mounting method, mounting location: surface-mounted, to the ceiling

Electrical connection

- Connection: terminal, 3+2-pole, max. 2.5mm²
- Nominal voltage: 230V, 230..240V, 50/60Hz, AC

Dimensions, Weight

- Diameter: 380mm
- Weight: 2.0kg

Order No.: 51DC112DD4400A | GTIN (EAN): 4069025358981

Dimensions: Lun11R,surf,wh4800lm840,DA2

