

Order No.: 51SM14MB11A2C | **GTIN (EAN):** 4069025531483

Product description: Spot21,wd,3860lm927,ML,90,wh



Spot 21, directional spotlight, light control with lens, of plastic, beam angle: wide distribution, LED rated luminous flux: 3.860lm, light colour: 927, with plug, 5-pole, with phase selection, mains connection: 220..240V, AC, 50/60Hz, of aluminium, traffic white (RAL 9016), diameter: 90mm, protection rating (complete): IP20, insulation class (complete): insulation class I (protective earthing), certification: CE, packaging unit: 1 piece

IP 20  

Lamps:	LED
Wt. (kg):	1.4
GTIN (EAN):	4069025531483



It is mandatory that the assembly instructions must be observed when planning and installing the electrical installation (to be found at www.siteco.com)

Tolerances related to thermal, electrical and photometric data according to IEC 62722

Issued 22.05.2026 - Modifications and errors subject to change - Ensure that you always use the latest version -

Order No.: 51SM14MB11A2C | GTIN (EAN): 4069025531483

Detailed technical description: Spot21,wd,3860lm927,ML,90,wh



Key data

- Product type: directional spotlight
- Product name: Spot 21
- Order No.: 51SM14MB11A2C

Lighting technology | Lamps | Control gear

Component 1

Lighting technology:

- Light control: lens of plastic
- Beam angle: wide distribution
- Symmetry: symmetric

Lamps:

- Lamps: with LED
- Rated luminous flux: 3860lm
- Luminous efficacy: 130lm/W
- Colour temperature: 2700K
- Colour rendering index: CRI > 90
- Light colour: 927
- SDCM (Standard Deviation of Colour Matching): MacAdam \leq 3 SDCM (initial)
- Rated input power: 29W

Operating device:

- Control: ON/OFF Multilumen

Certificates, Standards

- Protection rating: IP20
- Insulation class: insulation class I (protective earthing)
- Certification, designation: CE

Mounting

- Mounting method, mounting location: slip-in mounting, in the Modario trunking rail

Electrical connection

- Connection: plug, 5-pole, with phase selection
- Nominal voltage: 220..240V, 50/60Hz, AC

Dimensions, Weight

- Diameter: 90mm
- Weight: 1.4kg

Service life

- Rated service life: 50000h (L80/B50) at AT = 25°C

Order No.: 51SM14MB11A2C | GTIN (EAN): 4069025531483

Dimensions: Spot21,wd,3860lm927,ML,90,wh

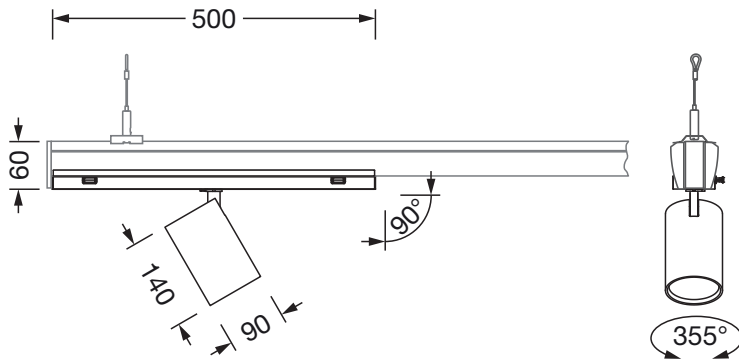

It is mandatory that the assembly instructions must be observed when planning and installing the electrical installation (to be found at www.siteco.com)
Tolerances related to thermal, electrical and photometric data according to IEC 62722
Issued 22.05.2026 - Modifications and errors subject to change - Ensure that you always use the latest version -