

**Order No.:** 51SM13DB11B2C | **GTIN (EAN):** 4069025531247

**Product description:** Spot21,med,4015lm930,DA2ML,90,wh



Spot 21, directional spotlight, light control with lens, of plastic, beam angle: medium distribution, LED rated luminous flux: 4.015lm, light colour: 930, with plug, 5-pole, with phase selection, mains connection: 220..240V, AC, 50/60Hz, of aluminium, traffic white (RAL 9016), diameter: 90mm, protection rating (complete): IP20, insulation class (complete): insulation class I (protective earthing), certification: CE, packaging unit: 1 piece

IP 20  

Lamps:	LED
Wt. (kg):	1.4
GTIN (EAN):	4069025531247



It is mandatory that the assembly instructions must be observed when planning and installing the electrical installation (to be found at [www.siteco.com](http://www.siteco.com))

Tolerances related to thermal, electrical and photometric data according to IEC 62722

Issued 22.05.2026 - Modifications and errors subject to change - Ensure that you always use the latest version -

Order No.: 51SM13DB11B2C | GTIN (EAN): 4069025531247

Detailed technical description: Spot21,med,4015lm930,DA2ML,90,wh



#### Key data

- Product type: directional spotlight
- Product name: Spot 21
- Order No.: 51SM13DB11B2C

#### Lighting technology | Lamps | Control gear

##### Component 1

#### Lighting technology:

- Light control: lens of plastic
- Beam angle: medium distribution
- Symmetry: symmetric

#### Lamps:

- Lamps: with LED
- Rated luminous flux: 4015lm
- Luminous efficacy: 130lm/W
- Colour temperature: 3000K
- Colour rendering index: CRI > 90
- Light colour: 930
- SDCM (Standard Deviation of Colour Matching): MacAdam  $\leq$  3 SDCM (initial)
- Rated input power: 31W

#### Operating device:

- Control: DALI 2, Multilumen

#### Certificates, Standards

- Protection rating: IP20
- Insulation class: insulation class I (protective earthing)
- Certification, designation: CE

#### Mounting

- Mounting method, mounting location: slip-in mounting, in the Modario trunking rail

#### Electrical connection

- Connection: plug, 5-pole, with phase selection
- Nominal voltage: 220..240V, 50/60Hz, AC

#### Dimensions, Weight

- Diameter: 90mm
- Weight: 1.4kg

#### Service life

- Rated service life: 50000h (L80/B50) at AT = 25°C

Order No.: 51SM13DB11B2C | GTIN (EAN): 4069025531247

Dimensions: Spot21,med,4015lm930,DA2ML,90,wh

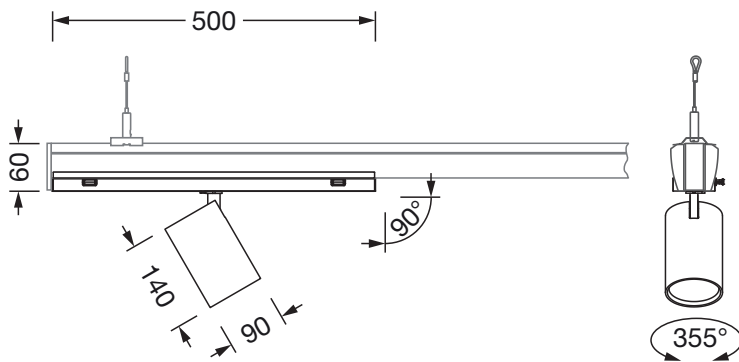

It is mandatory that the assembly instructions must be observed when planning and installing the electrical installation (to be found at [www.siteco.com](http://www.siteco.com))

Tolerances related to thermal, electrical and photometric data according to IEC 62722

Issued 22.05.2026 - Modifications and errors subject to change - Ensure that you always use the latest version -