

Order No.: 51DN167G42 | GTIN (EAN): 4058352556016

Product description: Lun31md,wd,2150lm840,0/1,wh



Lunis 31, midi, downlight, light control with reflector, light emission: direct distribution, LED rated luminous flux: 2.150lm, light colour: 840, mains connection: 220..240V, AC, 50/60Hz, housing, white, protection rating (complete): IP20, protection rating (on room side): IP54, insulation class (complete): insulation class II (safety insulation), certification: CE, packaging unit: 1 piece

IP 20  

Lamps:	LED
Wt. (kg):	0.5
GTIN (EAN):	4058352556016

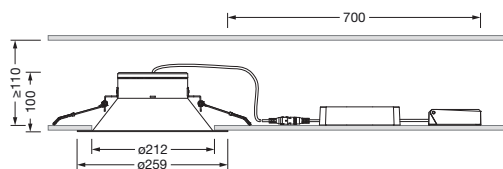

It is mandatory that the assembly instructions must be observed when planning and installing the electrical installation (to be found at www.siteco.com)

Tolerances related to thermal, electrical and photometric data according to IEC 62722

Issued 16.02.2024 - Modifications and errors subject to change - Ensure that you always use the latest version -

Order No.: 51DN167G42 | GTIN (EAN): 4058352556016

Detailed technical description: Lun31md,wd,2150lm840,0/1,wh



Key data

- Product type: downlight
- Product name: Lunis 31 midi
- Order No.: 51DN167G42

Lighting technology | Lamps | Control gear

Component 1

Lighting technology:

- Light control: reflector
- Beam angle: wide distribution
- Light emission: direct distribution
- UGR viewing direction along longitudinal luminaire axis: ≤ 22
- UGR viewing direction along lateral luminaire axis: ≤ 22

Lamps:

- Lamps: with LED
- Rated luminous flux: 2150lm
- Luminous efficacy: 127lm/W
- Colour temperature: 4000K
- Colour rendering index: CRI > 80
- Light colour: 840
- SDCM (Standard Deviation of Colour Matching): MacAdam ≤ 4 SDCM (initial)
- Rated input power: 17W

Operating device:

- Control: ON/OFF

Certificates, Standards

- Protection rating: IP20
- Protection rating (on room side): IP54
- Insulation class: insulation class II (safety insulation)
- Certification, designation: CE

Material, Colour

- Colour specification: white

Mounting

- Mounting method, mounting location: recessed, in the ceiling
- \varnothing of ceiling cut-out: 212mm
- Arrangement: single arrangement

Electrical connection

- Nominal voltage: 220..240V, 50/60Hz, AC

Dimensions, Weight

- Weight: 0.5kg

Service life

- Rated service life: 50000h (L80/B50) at AT = 25°C

Order No.: 51DN167G42 | GTIN (EAN): 4058352556016

Dimensions: Lun31md,wd,2150lm840,0/1,wh

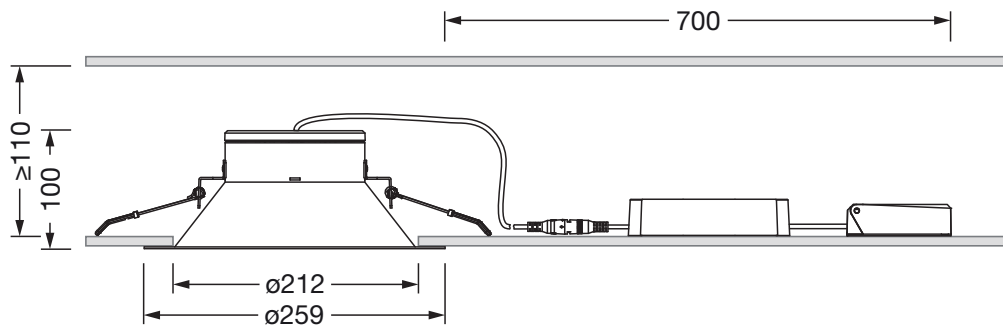

It is mandatory that the assembly instructions must be observed when planning and installing the electrical installation (to be found at www.siteco.com)

Tolerances related to thermal, electrical and photometric data according to IEC 62722

Issued 16.02.2024 - Modifications and errors subject to change - Ensure that you always use the latest version -