

Order No.: 5XA7100W50A22DA | GTIN (EAN): 4058352402849

Product description: Sirius,LH,ECO-RS05,217792lm957,1909W,IC1



Sirius® luminaire head; light control with light control via reflectors with silver coating of plastic, silver coated; cover of toughened safety glass, transparent; light distribution: ECO-RS05, rotationally symmetric direct distribution, LED (High Power LED), colour temperature: 5700K, rated luminous flux: 217.792lm, colour rendering: CRI > 95, Television Lighting Consistency Index: TLCI ≥ 96, light colour: 957; luminous efficacy: 114lm/W; with 2x connection cable with system connection, cable length: 1,2m; dimming range 5..100% per LED segment, LED unit replaceable without ESD environment, dustproof LED module; 1909W luminaire head with 2x LED unit of diecast aluminium, powder-coated Siteco® metallic grey (DB 702S); length: 792mm / width: 696mm / height: 126mm; protection rating (complete): IP66; insulation class (complete): insulation class I (protective earthing); certification: CE, ENEC; impact resistance: IK10; permissible operating ambient temperature: in outdoor areas: -30..+55°C, in indoor areas: -30..+45°C; permissible storage temperature: -20..+50°C; packaging unit: 1 piece



Lamps:	LED
Wt. (kg):	30.0
GTIN (EAN):	4058352402849



It is mandatory that the assembly instructions must be observed when planning and installing the electrical installation (to be found at www.siteco.com)

Tolerances related to thermal, electrical and photometric data according to IEC 62722

Issued 24.02.2023 - Modifications and errors subject to change - Ensure that you always use the latest version -

Order No.: 5XA7100W50A22DA | GTIN (EAN): 4058352402849

Detailed technical description: Sirius,LH,ECO-RS05,217792lm957,1909W,IC1



Key data

- Product type: luminaire head
- Product name: Sirius®
- Order No.: 5XA7100W50A22DA

Lighting technology | Lamps | Control gear

Component 1

Lighting technology:

- Light control: light control via reflectors with silver coating of plastic, silver coated
- Cover: cover, transparent
- Light distribution: ECO-RS05
- Symmetry: rotationally symmetric
- Light emission: direct distribution
- UGR viewing direction along longitudinal luminaire axis: ≤ 22
- UGR viewing direction along lateral luminaire axis: ≤ 22

Lamps:

- Lamps: with High Power LED, LED
- Rated luminous flux: 217792lm
- Luminous efficacy: 114lm/W
- Colour temperature: 5700K
- Colour rendering index: CRI > 95
- Light colour: 957
- TLCI (Television Light Consistency Index): TLCI ≥ 96
- Rated input power: 1909W
- Supplement: dimming range 5..100% per LED segment

Certificates, Standards

- Protection rating: IP66
- Insulation class: insulation class I (protective earthing)
- Impact resistance: IK10
- Temperature range (operation): in outdoor areas: -30..+55°C
- Certification, designation: CE, ENEC

Material, Colour

- LED unit: diecast aluminium, powder-coated, Siteco® metallic grey (DB 702S)
- Quantity: 2 piece
- Colour specification: Siteco® metallic grey (DB 702S)
- Cover: cover of toughened safety glass

Mounting

- Mounting method, mounting location: screw fastening, to supporting structure

Electrical connection

- Connection: 2x connection cable with system connection

Dimensions, Weight

- Length: 792mm
- Width: 696mm
- Height: 126mm
- Weight: 30.0kg

Service life

- Rated service life: 50000h (L90/B50) at AT = 25°C, 10000h (L97/B50) at AT = 25°C

Order No.: 5XA7100W50A22DA | GTIN (EAN): 4058352402849

Dimensions: Sirius,LH,ECO-RS05,217792Im957,1909W,IC1

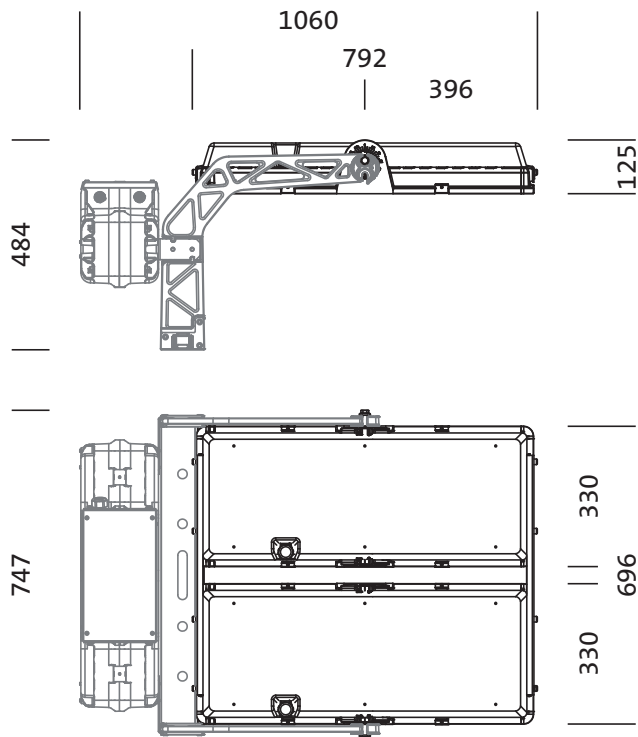

It is mandatory that the assembly instructions must be observed when planning and installing the electrical installation (to be found at www.siteco.com)

Tolerances related to thermal, electrical and photometric data according to IEC 62722

Issued 24.02.2023 - Modifications and errors subject to change - Ensure that you always use the latest version -