

**Order No.:** 5XA7100W40A72DA | **GTIN (EAN):** 4058352402788

**Product description:** Sirius,LH,ECO-RS14,264489lm950,1974W,IC1



Sirius® luminaire head; light control with light control via reflectors with silver coating of plastic, silver coated; cover of toughened safety glass, transparent; light distribution: ECO-RS14, rotationally symmetric direct distribution, LED (High Power LED), colour temperature: 5000K, rated luminous flux: 264.489lm, colour rendering: CRI > 90, Television Lighting Consistency Index: TLCI ≥ 87, light colour: 950; luminous efficacy: 134lm/W; with 2x connection cable with system connection, cable length: 1,2m; dimming range 5..100% per LED segment, LED unit replaceable without ESD environment, dustproof LED module; 1974W luminaire head with 2x LED unit of diecast aluminium, powder-coated Siteco® metallic grey (DB 702S); length: 792mm / width: 696mm / height: 126mm; protection rating (complete): IP66; insulation class (complete): insulation class I (protective earthing); certification: CE, ENEC; impact resistance: IK10; permissible operating ambient temperature: in outdoor areas: -30..+55°C, in indoor areas: -30..+45°C; permissible storage temperature: -20..+50°C; packaging unit: 1 piece



Lamps:	LED
Wt. (kg):	30.0
GTIN (EAN):	4058352402788



Order No.: 5XA7100W40A72DA | GTIN (EAN): 4058352402788

Detailed technical description: Sirius,LH,ECO-RS14,264489lm950,1974W,IC1



### Key data

- Product type: luminaire head
- Product name: Sirius®
- Order No.: 5XA7100W40A72DA

### Lighting technology | Lamps | Control gear

#### Component 1

#### Lighting technology:

- Light control: light control via reflectors with silver coating of plastic, silver coated
- Cover: cover, transparent
- Light distribution: ECO-RS14
- Symmetry: rotationally symmetric
- Light emission: direct distribution
- UGR viewing direction along longitudinal luminaire axis:  $\leq 22$
- UGR viewing direction along lateral luminaire axis:  $\leq 22$

#### Lamps:

- Lamps: with High Power LED, LED
- Rated luminous flux: 264489lm
- Luminous efficacy: 134lm/W
- Colour temperature: 5000K
- Colour rendering index: CRI > 90
- Light colour: 950
- TLCI (Television Light Consistency Index): TLCI  $\geq 87$
- Rated input power: 1974W
- Supplement: dimming range 5..100% per LED segment

#### Certificates, Standards

- Protection rating: IP66
- Insulation class: insulation class I (protective earthing)
- Impact resistance: IK10
- Temperature range (operation): in outdoor areas: -30..+55°C
- Certification, designation: CE, ENEC

#### Material, Colour

- LED unit: diecast aluminium, powder-coated, Siteco® metallic grey (DB 702S)
- Quantity: 2 piece
- Colour specification: Siteco® metallic grey (DB 702S)
- Cover: cover of toughened safety glass

### Mounting

- Mounting method, mounting location: screw fastening, to supporting structure

### Electrical connection

- Connection: 2x connection cable with system connection

### Dimensions, Weight

- Length: 792mm
- Width: 696mm
- Height: 126mm
- Weight: 30.0kg

### Service life

- Rated service life: 50000h (L90/B50) at AT = 25°C, 10000h (L97/B50) at AT = 25°C

Order No.: 5XA7100W40A72DA | GTIN (EAN): 4058352402788

Dimensions: Sirius,LH,ECO-RS14,264489Im950,1974W,IC1

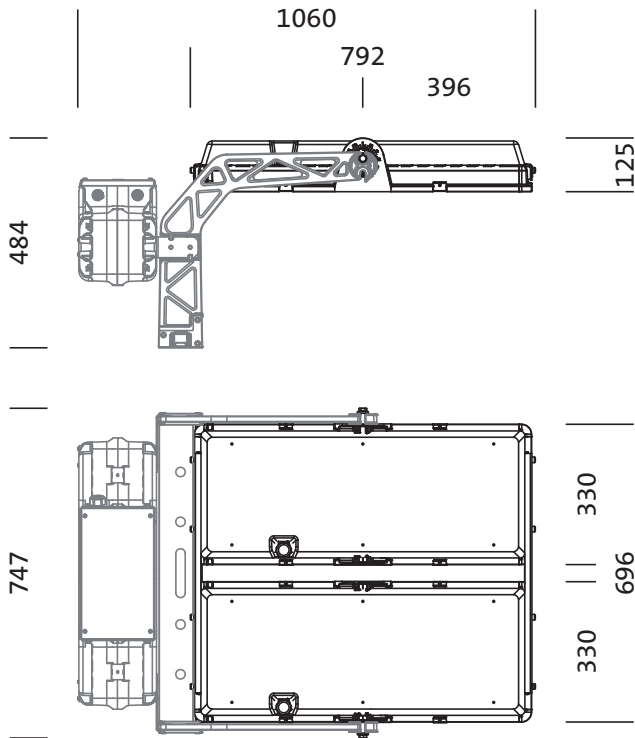

It is mandatory that the assembly instructions must be observed when planning and installing the electrical installation (to be found at [www.siteco.com](http://www.siteco.com))  
Tolerances related to thermal, electrical and photometric data according to IEC 62722  
Issued 24.02.2023 - Modifications and errors subject to change - Ensure that you always use the latest version -