

Order No.: 59HP91001 | GTIN (EAN): 4058352475829

Product description: HB42S/L,refl,PC,dir,surf

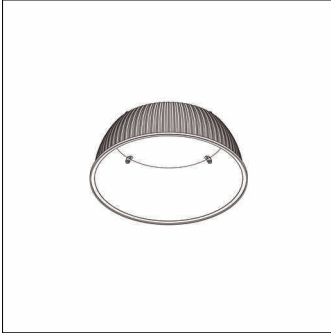
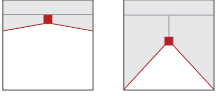

Highbay 42 S/L, reflector, primary light control with reflector, of PC, transparent prismatic structure, light emission: direct with ceiling illumination distribution, primary light characteristic: rotationally symmetric, installation type: surface-mounted, diameter: 410mm, height: 141mm, packaging unit: 1 piece

Wt. (kg): 0.5  
GTIN (EAN): 4058352475829

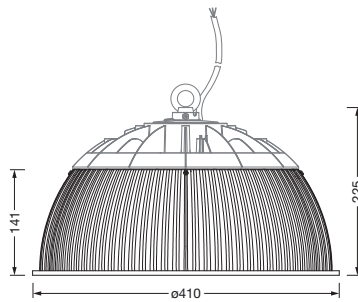

Order No.: 59HP91001 | GTIN (EAN): 4058352475829

Detailed technical description: HB42S/L,refl,PC,dir,surf

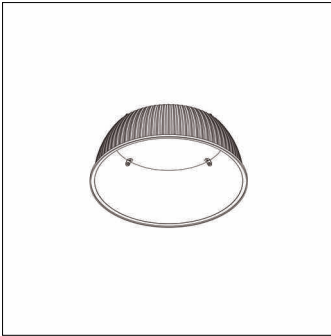

#### Key data

- Product type: reflector
- Product name: Highbay 42 S/L
- Order No.: 59HP91001

#### Lighting technology | Lamps | Control gear

#### Component 1

#### Lighting technology:

- Light control: reflector of PC, transparent prismatic structure
- Beam angle: wide distribution, 100°
- Symmetry: rotationally symmetric
- Light emission: direct with ceiling illumination

#### Mounting

- Mounting method, mounting location: surface-mounted, to the luminaire
- Arrangement: single arrangement
- Supplement: incl. adapter ring

#### Dimensions, Weight

- Diameter: 410mm
- Height: 141mm
- Weight: 0.5kg

Order No.: 59HP91001 | GTIN (EAN): 4058352475829

Dimensions: HB42S/L,refl,PC,dir,surf

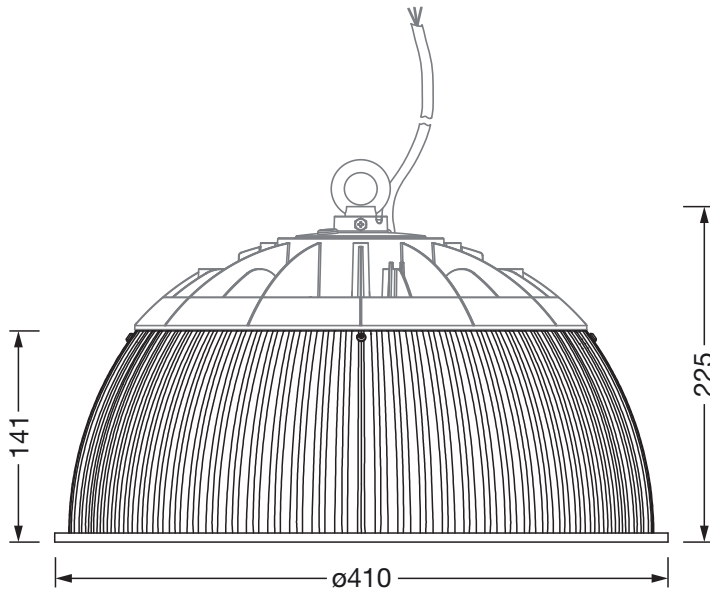

It is mandatory that the assembly instructions must be observed when planning and installing the electrical installation (to be found at [www.siteco.com](http://www.siteco.com))

Tolerances related to thermal, electrical and photometric data according to IEC 62722

Issued 24.11.2023 - Modifications and errors subject to change - Ensure that you always use the latest version -