

Order No.: 5XA779126A01AA | GTIN (EAN): 4058352537459

Product description: FL11mxpro,PL43,172790lm740,DA2



Floodlight FL 11 maxi pro floodlight; light control with lens of PMMA; cover panel of toughened safety glass, transparent; light distribution: PL43, asymmetric direct distribution, LED colour temperature: 4000K, rated luminous flux: 172.790lm, colour rendering: CRI > 70, light colour: 740; luminous efficacy: 125lm/W; brightness control: DALI 2 (1 DALI address); with terminal, 5-pole, max. 2.5mm², mains connection: 220..240V/380..400V AC, 50/60Hz, surge voltage resistance: line to ground: 10kV, dustproof LED module, LED unit replaceable without ESD environment, ECG replaceable separately, LED unit replaceable, LED unit replaceable on mast without ESD environment, dimming range 10..100%; 1388W floodlight with 3x LED unit of diecast aluminium, coated grey; length: 1.003mm / width: 651mm / height: 338mm; mounting bracket, of diecast aluminium, uncoated, natural, equipment: Power, protection rating (complete): IP66; insulation class (complete): insulation class I (protective earthing); certification: CE, ENEC, VDE; ball protection: ball impact resistant, impact resistance: IK07; rated ambient temperature 10°C, only for outdoor installations, permissible operating ambient temperature: -40..+30°C, permissible storage temperature: -40..+85°C; packaging unit: 1 piece



Lamps: LED
 Wt. (kg): 29.4
 GTIN (EAN): 4058352537459

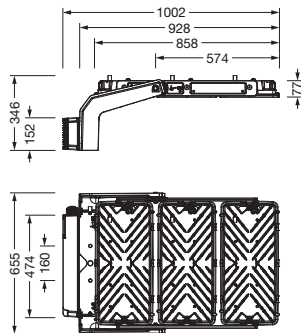

It is mandatory that the assembly instructions must be observed when planning and installing the electrical installation (to be found at www.siteco.com)

Tolerances related to thermal, electrical and photometric data according to IEC 62722

Issued 01.03.2024 - Modifications and errors subject to change - Ensure that you always use the latest version -

Order No.: 5XA779126A01AA | GTIN (EAN): 4058352537459

Detailed technical description: FL11mxpro,PL43,172790lm740,DA2



Key data

- Product type: floodlight
- Product name: Floodlight FL 11 maxi pro
- Order No.: 5XA779126A01AA

Lighting technology | Lamps | Control gear

Component 1

Lighting technology:

- Light control: lens of PMMA
- Cover: cover panel, transparent
- Light distribution: PL43
- Symmetry: asymmetric distribution
- Light emission: direct distribution

Lamps:

- Lamps: with LED
- Rated luminous flux: 172790lm
- Luminous efficacy: 125lm/W
- Colour temperature: 4000K
- Colour rendering index: CRI > 70
- Light colour: 740
- Rated input power: 1388W

Operating device:

- Control: DALI 2 (1 DALI address)

Certificates, Standards

- Protection rating: IP66
- Insulation class: insulation class I (protective earthing)
- Impact resistance: IK07
- Temperature range (operation): -40..+30°C
- Supplement: only for outdoor installations, rated ambient temperature 10°C
- Certification, designation: CE, ENEC, VDE

Material, Colour

- LED unit: diecast aluminium, coated, grey
- Quantity: 3 piece
- Colour specification: grey
- mounting bracket: diecast aluminium, uncoated, natural
- Colour specification: natural
- Cover: cover panel of toughened safety glass

Mounting

- Mounting method, mounting location: surface-mounted, to supporting structure, to the ceiling, to the cross arm
- Arrangement: single arrangement
- Supplement: with mounting bracket

Electrical connection

- Connection: terminal, 5-pole, max. 2.5mm²
- Nominal voltage: 220..240V/380..400V, 50/60Hz, AC
- Surge voltage resistance: line to ground: 10kV

Dimensions, Weight

- Length: 1003mm
- Width: 651mm
- Height: 338mm
- Weight: 29.4kg

Light emission

- Light emission: 0% at 0° inclination

Service life

- Rated service life: 10000h (L96/B10) at AT = 10°C, 75000h (L80/B10) at AT = 10°C

Order No.: 5XA779126A01AA | GTIN (EAN): 4058352537459

Dimensions: FL11mxpro,PL43,172790lm740,DA2



It is mandatory that the assembly instructions must be observed when planning and installing the electrical installation (to be found at www.siteco.com)

Tolerances related to thermal, electrical and photometric data according to IEC 62722

Issued 01.03.2024 - Modifications and errors subject to change - Ensure that you always use the latest version -