

Order No.: 51HC42DA4JMB | **GTIN (EAN):** 4058352700273

Product description: HB31L,rot.sym,90°,20000lm840,DA2



Highbay 31-L, high bay luminaire, primary light control with lens, of PC, primary optical cover: cover panel, of PC, transparent, light emission: direct distribution, primary light characteristic: rotationally symmetric, installation type: suspended mounting, surface-mounted, LED, rated luminous flux: 20.000lm, luminous efficacy: 150lm/W, light colour: 840, colour temperature: 4000K, control gear: DALI 2, with cable, 5x 1.0mm², free wire ends, mains connection: 220..240V, AC, 50/60Hz, cable length: 1,5m, rated input power: 134W, housing, rotationally symmetric, of diecast aluminium, powder-coated, grey aluminium (RAL 9007), with hook on luminaire side, incl. screw, diameter: 404mm, protection rating (complete): IP65, insulation class (complete): insulation class I (protective earthing), certification: CE, ENEC, UKCA, protection symbol: D, impact resistance: IK08, permissible operating ambient temperature: -30..+45°C, corresponds to IFS (International Featured Standards) requirements for safety and quality in the food industry, packaging unit: 1 piece



Lamps:	LED
Wt. (kg):	3.7
GTIN (EAN):	4058352700273

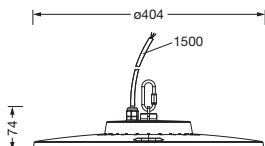

Order No.: 51HC42DA4JMB | **GTIN (EAN):** 4058352700273

Detailed technical description: HB31L,rot.sym,90°,20000lm840,DA2



Key data

- Product type: high bay luminaire
- Product name: Highbay 31-L
- Order No.: 51HC42DA4JMB

Lighting technology | Lamps | Control gear

Component 1

Lighting technology:

- Light control: lens of PC
- Cover: cover panel, transparent
- Beam angle: 90°
- Symmetry: rotationally symmetric
- Light emission: direct distribution
- UGR viewing direction along longitudinal luminaire axis: ≤ 25
- UGR viewing direction along lateral luminaire axis: ≤ 25

Lamps:

- Lamps: with LED
- Rated luminous flux: 20000lm
- Luminous efficacy: 150lm/W
- Colour temperature: 4000K
- Colour rendering index: CRI > 80
- Light colour: 840
- SDCM (Standard Deviation of Colour Matching): MacAdam ≤ 4 SDCM (initial)
- Rated input power: 134W
- Supplement: without flicker

Operating device:

- Control: DALI 2

Certificates, Standards

- Protection rating: IP65
- Insulation class: insulation class I (protective earthing)
- Impact resistance: IK08
- Protection symbol: D
- Temperature range (operation): -30..+45°C
- Supplement: corresponds to IFS (International Featured Standards) requirements for safety and quality in the food industry
- Certification, designation: CE, ENEC, UKCA

Material, Colour

- housing: diecast aluminium, powder-coated, grey aluminium (RAL 9007), rotationally symmetric, with hook on luminaire side, incl. screw
- Quantity: 1 piece
- Cover: cover panel of PC

Mounting

- Mounting method, mounting location: suspended mounting, surface-mounted, to the ceiling, to the chain
- Arrangement: single arrangement
- Supplement: only suitable for use in indoor areas, mounting accessories required, please order separately

Electrical connection

- Connection: cable, 5x 1.0mm², free wire ends
- Nominal voltage: 220..240V, 50/60Hz, AC

Dimensions, Weight

- Diameter: 404mm
- Weight: 3.7kg

Service life

- Rated service life: 100000h (L70) at AT = 35°C, 70000h (L80) at AT = 45°C, 50000h (L85) at AT = 45°C

Order No.: 51HC42DA4JMB | GTIN (EAN): 4058352700273

Dimensions: HB31L,rot.sym,90°,2000lm840,DA2

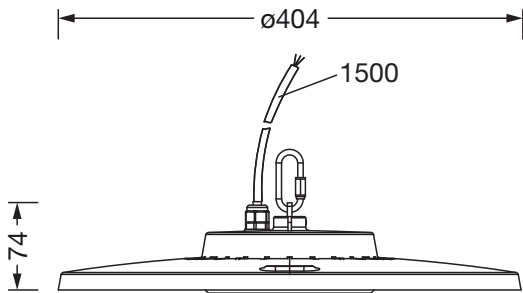

It is mandatory that the assembly instructions must be observed when planning and installing the electrical installation (to be found at www.siteco.com)

Tolerances related to thermal, electrical and photometric data according to IEC 62722

Issued 14.02.2026 - Modifications and errors subject to change - Ensure that you always use the latest version -