

**Order No.:** 5XA7782E4D3A | **GTIN (EAN):** 4058352853894

**Product description:** FL21iQmd,PL52,28010lm740,SR,mastbr



Floodlight FL 21 iQ midi, floodlight, primary light control with lens, of PMMA, primary optical cover: protective disc, of toughened safety glass, transparent, light distribution: PL52, light emission: direct distribution, installation type: surface-mounted, LED, High Power LED, rated luminous flux: 28.010lm, luminous efficacy: 135lm/W, light colour: 740, colour temperature: 4000K, control gear: ECG iQ, control: optimised constant luminous flux control (CLO 2.0), Desk-Remote (wireless, voltage-free reading and setting of iQ features in the workshop via application-optimized NFC function/RFID function), Smart-Wire, Night-Set, Temp-Guard, Auto-Match, Street-Remote, with terminal, 6-pole, mains connection: 220..240V, AC, 50/60Hz, start of lifetime: 208W, end of service life: 227W, reduction: 90W, luminaire housing, of diecast aluminium, powder-coated, Siteco® metallic grey (DB 702S), corrosivity category C5 mid according to DIN EN ISO 12944, sealing non-destructively replaceable, please order mast flange separately, mast bracket, of steel, galvanised, powder-coated, Siteco® metallic grey (DB 702S), protection rating (complete): IP66, insulation class (complete): insulation class II (safety insulation), certification: CE, protection symbol: D, impact resistance: IK08, permissible operating ambient temperature: -40..+40°C, permissible operating ambient temperature for outdoor applications: -40..+50°C, standard: DIN EN 12944, LABS conformity tested according to VDMA 24364:2018-05, packaging unit: 1 piece

IP 66 IK 08

Lamps: LED  
 Wt. (kg): 10.2  
 GTIN (EAN): 4058352853894

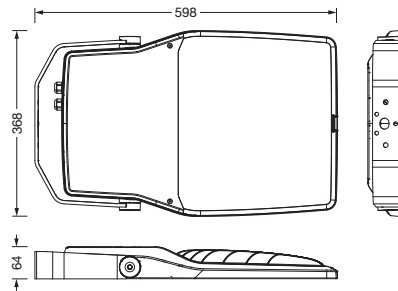

It is mandatory that the assembly instructions must be observed when planning and installing the electrical installation (to be found at [www.siteco.com](http://www.siteco.com))

Tolerances related to thermal, electrical and photometric data according to IEC 62722

Issued 13.04.2024 - Modifications and errors subject to change - Ensure that you always use the latest version -

Order No.: 5XA7782E4D3A | GTIN (EAN): 4058352853894

Detailed technical description: FL21iQmd,PL52,28010lm740,SR,mastbr



### Key data

- Product type: floodlight
- Product name: Floodlight FL 21 iQ midi
- Order No.: 5XA7782E4D3A

### Lighting technology | Lamps | Control gear

#### Component 1

#### Lighting technology:

- Light control: lens of PMMA
- Cover: protective disc, transparent
- Light distribution: PL52
- Light emission: direct distribution

#### Lamps:

- Lamps: with High Power LED, LED
- Rated luminous flux: 28010lm
- Luminous efficacy: 135lm/W
- Colour temperature: 4000K
- Colour rendering index: CRI > 70
- Light colour: 740
- Rated input power begin service life: 208
- Rated input power end service life: 227
- Rated input power at 50% lumin. flux: 90
- Supplement: prepared for through-wiring

#### Operating device:

- Control gear: ECG iQ
- Control: iQ Street-Remote
- Equipment: optimised constant luminous flux control (CLO 2.0), Desk-Remote (wireless, voltage-free reading and setting of iQ features in the workshop via application-optimized NFC function/RFID function), Smart-Wire, Night-Set, Temp-Guard, Auto-Match, Street-Remote

### Certificates, Standards

- Protection rating: IP66
- Insulation class: insulation class II (safety insulation)
- Impact resistance: IK08
- Protection symbol: D
- Temperature range (operation): -40..+40°C
- Supplement: LABS conformity tested according to VDMA 24364:2018-05
- Standard: DIN EN 12944
- Corrosion protection: corrosivity category C5 mid according to DIN EN ISO 12944
- Certification, designation: CE

### Material, Colour

- luminaire housing: diecast aluminium, powder-coated, Siteco® metallic grey (DB 702S), sealing non-destructively replaceable, please order mast flange separately
- Colour specification: Siteco® metallic grey (DB 702S)
- mast bracket: steel, galvanised, powder-coated, Siteco® metallic grey (DB 702S)
- Colour specification: Siteco® metallic grey (DB 702S)
- Cover: protective disc of toughened safety glass

### Mounting

- Mounting method, mounting location: surface-mounted, to mast
- Arrangement: single arrangement
- Supplement: with mounting bracket

### Electrical connection

- Connection: terminal, 6-pole
- Nominal voltage: 220..240V, 50/60Hz, AC
- Surge voltage resistance: surge voltage resistance: 10kV (common mode); 6kV (differential mode)

### Dimensions, Weight

- Weight: 10.2kg

### Service life

- Rated service life: 50000h (L95/B10) at AT = -25°C

Order No.: 5XA7782E4D3A | GTIN (EAN): 4058352853894

Dimensions: FL21iQmd,PL52,28010lm740,SR,mastbr

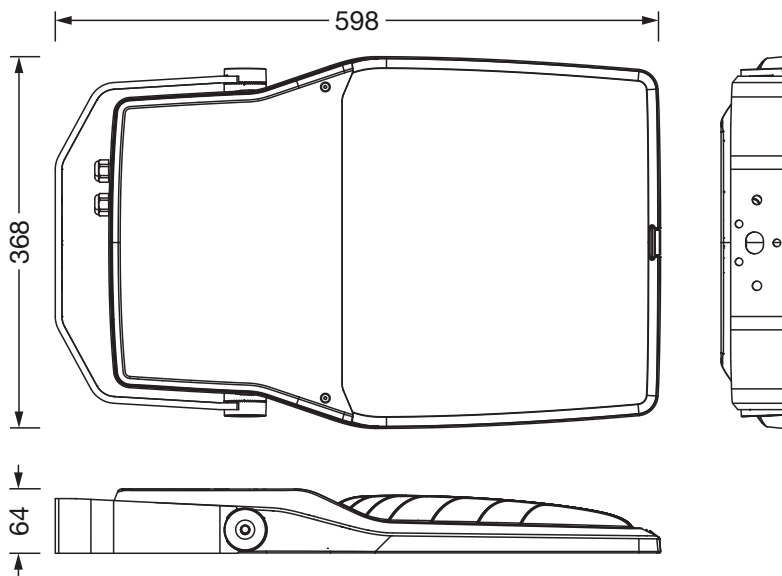

It is mandatory that the assembly instructions must be observed when planning and installing the electrical installation (to be found at [www.siteco.com](http://www.siteco.com))

Tolerances related to thermal, electrical and photometric data according to IEC 62722

Issued 13.04.2024 - Modifications and errors subject to change - Ensure that you always use the latest version -