

Order No.: 5PJBO1D3204A | **GTIN (EAN):** 4058352958957

Product description: Sil21Ring-O,3930lm840,DA2,610,sr



Silica® 21 Ring-O, suspended luminaire, of PMMA, frosted, light emission: outer ring side luminous distribution, primary light characteristic: symmetric, installation type: suspended mounting, LED, rated luminous flux: 3.930lm, luminous efficacy: 66lm/W, light colour: 840, colour temperature: 4000K, with terminal, 5-pole, mains connection: 230V, AC/DC, 0/50..60Hz, rated input power: 60W, housing, of extruded aluminium section, metallic grey (RAL 9006), diameter: 610mm, ceiling canopy, metallic grey (RAL 9006), protection rating (lamp compartment): IP40, insulation class (complete): insulation class I (protective earthing), certification: CE, impact resistance: IK02, permissible operating ambient temperature: 0..+35°C, packaging unit: 1 piece



Lamps:	LED
Wt. (kg):	2.2
GTIN (EAN):	4058352958957

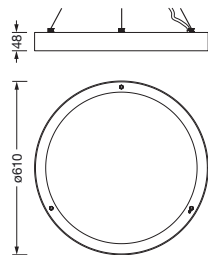

Order No.: 5PJBO1D3204A | GTIN (EAN): 4058352958957

Detailed technical description: Sil21Ring-O,3930lm840,DA2,610,sr



Key data

- Product type: suspended luminaire
- Product name: Silica® 21 Ring-O
- Order No.: 5PJBO1D3204A

Lighting technology | Lamps | Control gear

Component 1

Lighting technology:

- Beam angle: wide distribution
- Symmetry: symmetric
- Light emission: outer ring side luminous

Lamps:

- Lamps: with LED
- Rated luminous flux: 3930lm
- Luminous efficacy: 66lm/W
- Colour temperature: 4000K
- Colour rendering index: CRI > 80
- Light colour: 840
- SDCM (Standard Deviation of Colour Matching): MacAdam ≤ 3 SDCM (initial)
- Rated input power: 60W

Operating device:

- Control: DALI 2

Certificates, Standards

- Protection rating (lamp compartment): IP40
- Insulation class: insulation class I (protective earthing)
- Impact resistance: IK02
- Temperature range (operation): 0..+35°C
- Certification, designation: CE

Material, Colour

- housing: extruded aluminium section, metallic grey (RAL 9006)
- Colour specification: metallic grey (RAL 9006)
- Colour specification: metallic grey (RAL 9006)

Mounting

- Mounting method, mounting location: suspended mounting
- Recommended suspension height: up to 4.0m
- Arrangement: single arrangement

Electrical connection

- Connection: terminal, 5-pole
- Nominal voltage: 230V, 0/50..60Hz, AC/DC

Dimensions, Weight

- Diameter: 610mm
- Weight: 2.2kg

Service life

- Rated service life: 50000h (L80/B50) at AT = 25°C

Order No.: 5PJBO1D3204A | GTIN (EAN): 4058352958957

Dimensions: Sil21Ring-O,3930lm840,DA2,610,sr

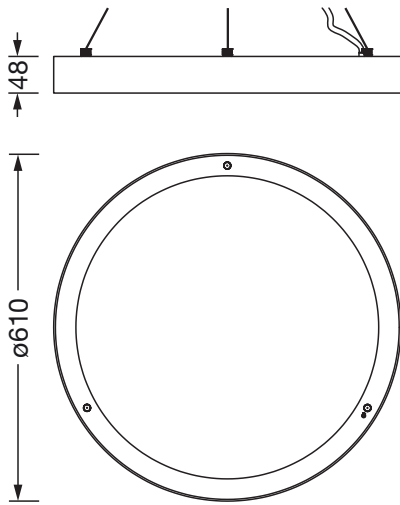

It is mandatory that the assembly instructions must be observed when planning and installing the electrical installation (to be found at www.siteco.com)

Tolerances related to thermal, electrical and photometric data according to IEC 62722

Issued 13.10.2023 - Modifications and errors subject to change - Ensure that you always use the latest version -