

Order No.: 5XA779414W01AA | GTIN (EAN): 4058352977521

Product description: FL11mxRe,PL64BLC,73350lm957,DA2



Floodlight FL 11 maxi Remote floodlight; light control with lens of PMMA; cover panel of toughened safety glass, transparent; light distribution: PL64BLC, asymmetric direct distribution, LEDcolour temperature: 5700K, rated luminous flux: 73.350lm, colour rendering: CRI > 90, light colour: 957; luminous efficacy: 72lm/W; brightness control: DALI 2 (1 DALI address); with terminal, 8-pole, max. 2.5mm<sup>2</sup>, mains connection: 220..240V/380..400V AC, 50/60Hz, surge voltage resistance: line to ground: 10kV, ECG replaceable separately, LED unit replaceable without ESD environment, dustproof LED module, LED unit replaceable, LED unit replaceable on mast without ESD environment, dimming range 10..100%; 1016W floodlight with 2x LED unit of diecast aluminium, coated grey; length: 713mm / width: 651mm / height: 338mm; mounting bracket, of diecast aluminium, uncoated, natural, equipment: Power, protection rating (complete): IP66; insulation class (complete): insulation class I (protective earthing); certification: CE, ENEC, VDE; ball protection: ball impact resistance with accessories, impact resistance: IK07; only for outdoor installations, rated ambient temperature 10°C, permissible operating ambient temperature: -40..+30°C, permissible storage temperature: -40..+85°C; packaging unit: 1 piece



Lamps:	LED
Wt. (kg):	23.2
GTIN (EAN):	4058352977521



It is mandatory that the assembly instructions must be observed when planning and installing the electrical installation (to be found at [www.siteco.com](http://www.siteco.com))

Tolerances related to thermal, electrical and photometric data according to IEC 62722

Issued 01.03.2024 - Modifications and errors subject to change - Ensure that you always use the latest version -

Order No.: 5XA779414W01AA | GTIN (EAN): 4058352977521

Detailed technical description: FL11mxRe,PL64BLC,73350lm957,DA2



#### Key data

- Product type: floodlight
- Product name: Floodlight FL 11 maxi Remote
- Order No.: 5XA779414W01AA

#### Lighting technology | Lamps | Control gear

#### Component 1

#### Lighting technology:

- Light control: lens of PMMA
- Cover: cover panel, transparent
- Light distribution: PL64BLC
- Symmetry: asymmetric distribution
- Light emission: direct distribution

#### Lamps:

- Lamps: with LED
- Rated luminous flux: 73350lm
- Luminous efficacy: 72lm/W
- Colour temperature: 5700K
- Colour rendering index: CRI > 90
- Light colour: 957
- Rated input power: 1016W

#### Operating device:

- Control: DALI 2 (1 DALI address)

#### Certificates, Standards

- Protection rating: IP66
- Insulation class: insulation class I (protective earthing)
- Impact resistance: IK07
- Temperature range (operation): -40..+30°C
- Supplement: only for outdoor installations, rated ambient temperature 10°C
- Certification, designation: CE, ENEC, VDE

#### Material, Colour

- LED unit: diecast aluminium, coated, grey
- Quantity: 2 piece
- Colour specification: grey
- mounting bracket: diecast aluminium, uncoated, natural
- Colour specification: natural
- Cover: cover panel of toughened safety glass

#### Mounting

- Mounting method, mounting location: surface-mounted, to supporting structure, to the ceiling, to the cross arm
- Supplement: luminaire head with bracket 17.6kg, control gear 5.6kg
- Arrangement: single arrangement
- Supplement: with mounting bracket

#### Electrical connection

- Connection: terminal, 8-pole, max. 2.5mm<sup>2</sup>
- Nominal voltage: 220..240V/380..400V, 50/60Hz, AC
- Surge voltage resistance: line to ground: 10kV

#### Dimensions, Weight

- Length: 713mm
- Width: 651mm
- Height: 338mm
- Weight: 23.2kg

#### Light emission

- Light emission: 0% at 0° inclination

#### Service life

- Rated service life: 10000h (L96/B10) at AT = 10°C, 75000h (L80/B10) at AT = 10°C

Order No.: 5XA779414W01AA | GTIN (EAN): 4058352977521

Dimensions: FL11mxRe,PL64BLC,73350lm957,DA2

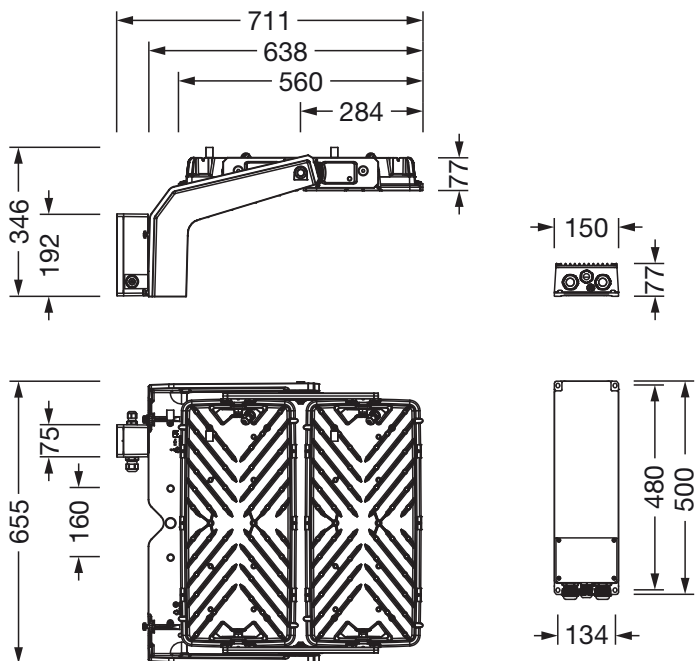

It is mandatory that the assembly instructions must be observed when planning and installing the electrical installation (to be found at [www.siteco.com](http://www.siteco.com))

Tolerances related to thermal, electrical and photometric data according to IEC 62722

Issued 01.03.2024 - Modifications and errors subject to change - Ensure that you always use the latest version -