

Order No.: 5XCMOD2E4HC | **GTIN (EAN):** 4058352392140

Product description: SL11,Plusmnmd,LEDmod,PCL,740



Streetlight SL 11 Plus mini/midi, LED module, light distribution: PC-L, primary light characteristic: asymmetric, left, High Power LED, light colour: 740, colour temperature: 4000K, mains connection: 230V, 50Hz, LED module, protection rating (complete): as luminaire, packaging unit: 1 piece

Wt. (kg): 1.4
GTIN (EAN): 4058352392140

Order No.: 5XCMOD2E4HC | GTIN (EAN): 4058352392140

Detailed technical description: SL11,Plusmnm,LEDmod,PCL,740

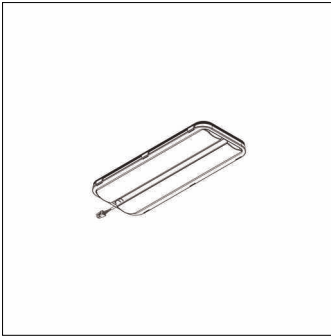

Key data

- Product type: LED module
- Product name: Streetlight SL 11 Plus mini/midi
- Order No.: 5XCMOD2E4HC

Lighting technology | Lamps | Control gear

Component 1

Lighting technology:

- Light distribution: PC-L
- Beam angle: wide distribution
- Symmetry: asymmetric, left

Lamps:

- Lamps: with High Power LED
- Colour temperature: 4000K
- Colour rendering index: CRI > 70
- Light colour: 740

Certificates, Standards

- Protection rating: as luminaire

Electrical connection

- Nominal voltage: 230V, 50Hz

Dimensions, Weight

- Weight: 1.4kg