

Order No.: 5XMOD1165K | **GTIN (EAN):** 4058352780855

Product description: SL10mnmd,LEDmod,ST1.2a,727

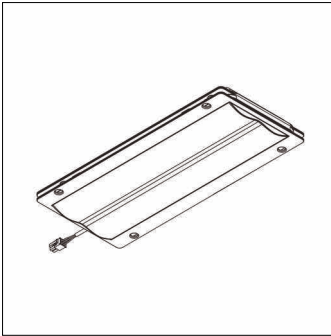

Streetlight 10 mini/midi, LED module, light distribution: ST1.2a, primary light characteristic: asymmetric, High Power LED, light colour: 727, colour temperature: 2700K, mains connection: 230..240V, 50Hz, LED module, length: 310mm, width: 137mm, height: 40mm, protection rating (complete): as luminaire, packaging unit: 1 piece

Wt. (kg): 1.3
GTIN (EAN): 4058352780855

Order No.: 5XMOD1165K | GTIN (EAN): 4058352780855

Detailed technical description: SL10mmmd,LEDmod,ST1.2a,727

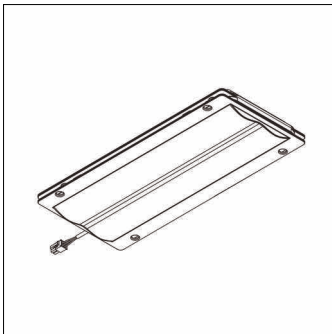

Key data

- Product type: LED module
- Product name: Streetlight 10 mini/midi
- Order No.: 5XMOD1165K

Lighting technology | Lamps | Control gear

Component 1

Lighting technology:

- Light distribution: ST1.2a
- Beam angle: wide distribution
- Symmetry: asymmetric distribution

Lamps:

- Lamps: with High Power LED
- Colour temperature: 2700K
- Colour rendering index: CRI > 70
- Light colour: 727
- Supplement: power consumption when used in Streetlight 10 Plus luminaires:
construction size mini 18.5..26.0W,
construction size midi 51.9..73.5W

Certificates, Standards

- Protection rating: as luminaire

Electrical connection

- Nominal voltage: 230..240V, 50Hz

Dimensions, Weight

- Length: 310mm
- Width: 137mm
- Height: 40mm
- Weight: 1.3kg