

Order No.: 5NYHALRL201 | **GTIN (EAN):** 4069025213228

Product description: r-l-mast,steel,galv,20m

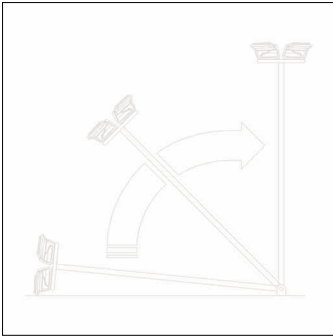

mast, raise and lower mast, installation type: screw fastening, raise and lower mast, of steel, galvanised, for up to 4 pcs. Floodlight FL 11 maxi pro in wind zone 1, for up to 3 pcs. Floodlight FL 11 maxi pro in wind zone 2, height: 20m, mast doors, of steel, galvanised, width: 170mm, height: 350mm, standard: DIN EN 40, packaging unit: 1 piece

Wt. (kg): 794.0
 GTIN (EAN): 4069025213228

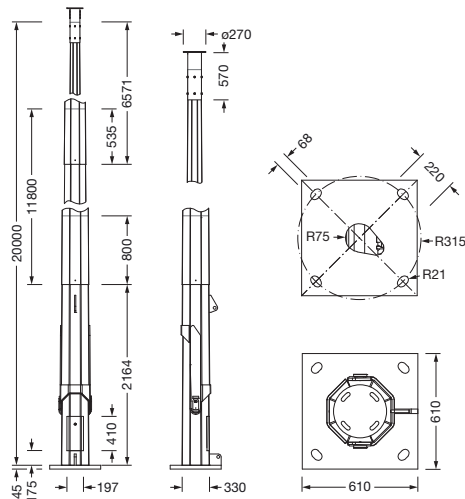

It is mandatory that the assembly instructions must be observed when planning and installing the electrical installation (to be found at www.siteco.com)
 Tolerances related to thermal, electrical and photometric data according to IEC 62722
 Issued 25.07.2025 - Modifications and errors subject to change - Ensure that you always use the latest version -

Order No.: 5NYHALRL201 | GTIN (EAN): 4069025213228

Detailed technical description: r-l-mast,steel,galv,20m

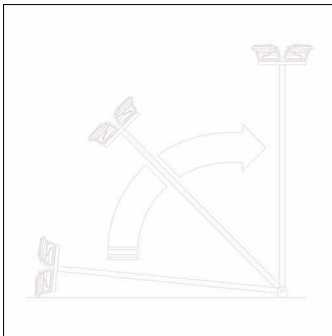

Key data

- Product type: raise and lower mast
- Product name: mast
- Order No.: 5NYHALRL201

Certificates, Standards

- Standard: DIN EN 40

Material, Colour

- raise and lower mast: steel, galvanised, for up to 4 pcs. Floodlight FL 11 maxi pro in wind zone 1, for up to 3 pcs. Floodlight FL 11 maxi pro in wind zone 2
- mast doors: steel, galvanised

Mounting

- Mounting method, mounting location: screw fastening, on foundation
- Supplement: fastening with four fastening bolts M36 x 1200mm, strength class 8.8, not included

Dimensions, Weight

- Height: 20m
- Weight: 794.0kg
- Supplement: for heavy loads

Order No.: 5NYHALRL201 | GTIN (EAN): 4069025213228

Dimensions: r-l-mast, steel, galv, 20m

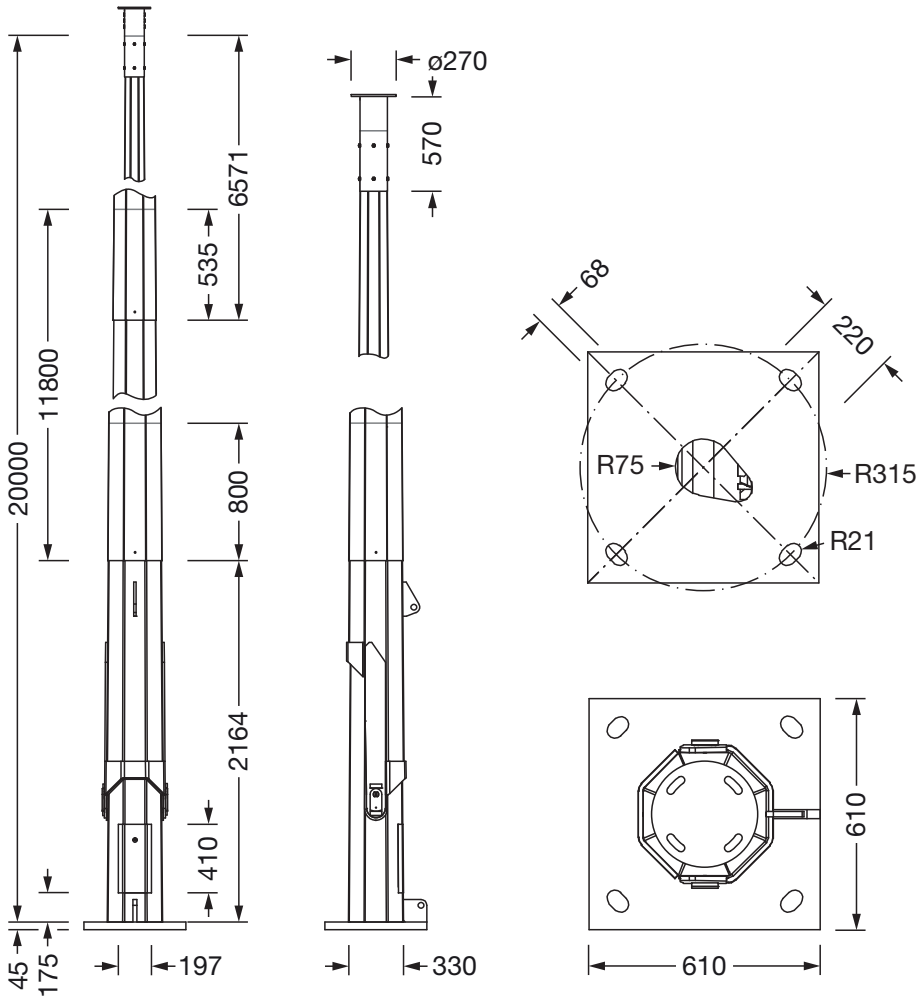

It is mandatory that the assembly instructions must be observed when planning and installing the electrical installation (to be found at www.siteco.com)
 Tolerances related to thermal, electrical and photometric data according to IEC 62722
 Issued 25.07.2025 - Modifications and errors subject to change - Ensure that you always use the latest version -