

Order No.: 51HN12DA4FDA03 | GTIN (EAN): 4069025241207

Product description: HB11md,wd,15000lm840,DA2,M-Sens

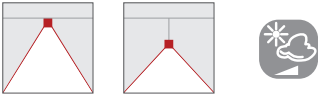

high bay luminaire Highbay 11 midi; direct symmetric wide distribution, light control with lens of PMMA; $UGR \leq 22$ ($X = 4H$ | $Y = 8H$ | $S = 0.25H$ | reflection values 70/50/20); luminous flux: 15.000lm; light colour: 840, colour temperature: 4000K, MacAdam ≤ 2 SDCM (initial), colour rendering: CRI > 80; luminous efficacy: 204,9lm/W; rated service life: 100.000h (L95) at AT= 25°C; control: DALI 2; for wired networking: open and standardized DALI2 interface enables full flexibility and future-proofing for changes in use or functional adaptation through individual programming; multi-sensor luminaire consisting of a DALI2 multi-sensor and DALI2 ECG; multi-sensor luminaire for wired connection to a DALI2 application controller (e.g., SITECO Connect 11 or 21); can also be connected to existing on-site lighting or building automation systems upon request; integrated DALI2 sensor certified according to IEC 62386, Parts 101, 103, 303, and 304; integrated DALI2 ECG provides luminaire data (according to IEC 62386, Part 251), energy data (Part 252), and monitoring and analytics data (Part 253) to higher-level systems for further processing; luminaire with PIR sensor (passive-infrared); with light sensor; luminaire connection: terminal, 5-pole, max. 2.5mm² (cable entry for one cable, \varnothing 8.5..16mm); mains connection: 230..240V, AC 50/60Hz; connected load: 73,2W; protection rating (complete): IP65; insulation class (complete): insulation class I (protective earthing); protection symbol: D; certification: CE, UKCA; internal wiring halogen-free; luminaire Suitable for use in the food industry according to the specifications of IFS-Food, HACCP and/or BRC; LABS conformity tested according to VDMA 24364:2018-05; housing frame of high-performance plastic PA6, matt traffic white (RAL 9016); cover of PMMA; dimension (LxWxH): 474 x 442 x 72mm; permissible operating ambient temperature: -20..+40°C (reducing of maximum allowable ambient temperature of 5°C with ceiling mounting); packaging unit: 1 piece; (delivery without accessories; please order mounting accessories separately)



Lamps:	LED
Wt. (kg):	3.7
GTIN (EAN):	4069025241207

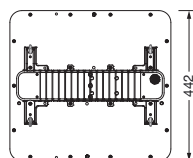
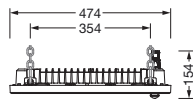

It is mandatory that the assembly instructions must be observed when planning and installing the electrical installation (to be found at www.siteco.com)

Tolerances related to thermal, electrical and photometric data according to IEC 62722

Issued 20.03.2026 - Modifications and errors subject to change - Ensure that you always use the latest version -

Order No.: 51HN12DA4FDA03 | **GTIN (EAN):** 4069025241207

Detailed technical description: HB11md,wd,15000lm840,DA2,M-Sens



Key data

- System family: SITECO Connect 11, SITECO Connect 21 O
- Product type: high bay luminaire
- Product name: Highbay 11 midi
- Order No.: 51HN12DA4FDA03

Lighting technology | Lamps | Control gear

Component 1

Lighting technology:

- Light control: lens of PMMA
- Cover: cover
- Beam angle: wide distribution
- Symmetry: symmetric
- Light emission: direct distribution
- UGR viewing direction along longitudinal luminaire axis: ≤ 22
- UGR viewing direction along lateral luminaire axis: ≤ 22

Lamps:

- Lamps: with LED
- Rated luminous flux: 15000lm
- Luminous efficacy: 205lm/W
- Colour temperature: 4000K
- Colour rendering index: CRI > 80
- Light colour: 840
- SDCM (Standard Deviation of Colour Matching): MacAdam ≤ 2 SDCM (initial)
- Rated input power: 73.2W
- Supplement: internal wiring halogen-free

Operating device:

- Control: DALI 2, dimmable

Certificates, Standards

- Protection rating: IP65
- Insulation class: insulation class I (protective earthing)
- Protection symbol: D
- Temperature range (operation): -20..+40°C
- Supplement: LABS conformity tested according to VDMA 24364:2018-05, Suitable for use in the food industry according to the specifications of IFS-Food, HACCP and/or BRC
- Certification, designation: CE, UKCA

Material, Colour

- housing frame: high-performance plastic PA6, matt traffic white (RAL 9016)
- Cover: cover of PMMA

Mounting

- Mounting method, mounting location: suspended mounting, surface-mounted, to wire, to the ceiling, to the chain
- Mounting height: 5..17m
- Arrangement: single arrangement

Electrical connection

- Connection: terminal, 5-pole, max. 2.5mm²
- Nominal voltage: 230..240V, 50/60Hz, AC

Dimensions, Weight

- Length: 474mm
- Width: 442mm
- Height: 72mm
- Weight: 3.7kg

Service life

- Rated service life: 100000h (L95) at AT = 25°C, 100000h (L90) at AT = ta max

Inputs

PIR sensor (passive-infrared)

- Connection: motion sensor technology
- Detection angle: 360°
- Detection range: at mounting height (Mh) = 15m: tangential max. $\varnothing 21m$ | at Mh = 7.5m: tangential max. $\varnothing 10.5m$
- Feature: circular detection area

light sensor

- Connection: daylight sensor technology
- Detection angle: 60°
- Detection range: measuring range on the ground at mounting height (Mh) = 5m: \varnothing approx. 5.6m | at Mh = 6m: \varnothing approx. 6.8m
- Illuminance: 5..5000lx (measured at sensor)

Outputs

DALI-2

- System current: max. 12mA

Order No.: 51HN12DA4FDA03 | GTIN (EAN): 4069025241207

Dimensions: HB11md,wd,15000Im840,DA2,M-Sens

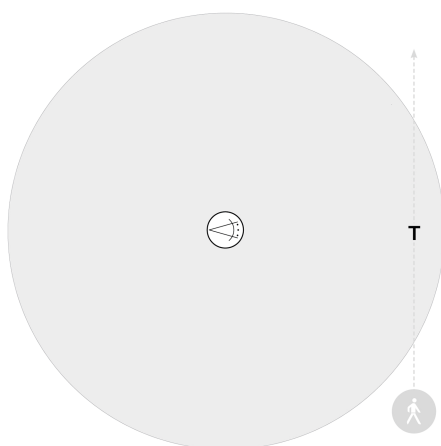
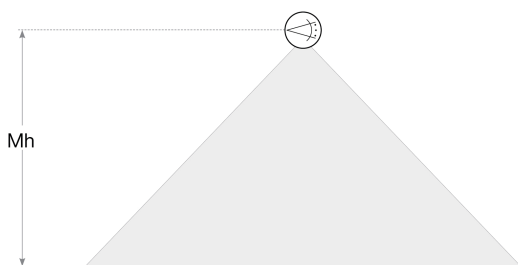
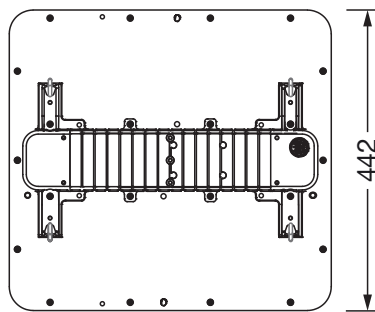
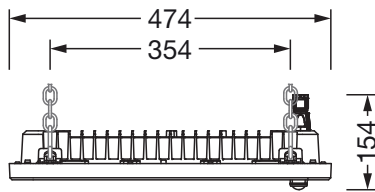

Sensor PC 11

Mh	T
7,5m	ø = 10,5m
15m	ø = 21m

It is mandatory that the assembly instructions must be observed when planning and installing the electrical installation (to be found at www.siteco.com)

Tolerances related to thermal, electrical and photometric data according to IEC 62722

Issued 20.03.2026 - Modifications and errors subject to change - Ensure that you always use the latest version -