

Order No.: 51HN12DA4MDA03 | GTIN (EAN): 4069025241269

Product description: HB11md,wd,28000lm840,DA2,M-Sens

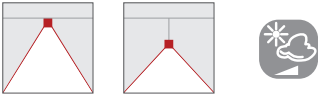

high bay luminaire Highbay 11 midi; direct symmetric wide distribution, light control with lens of PMMA;  $UGR \leq 22$  ( $X = 4H$  |  $Y = 8H$  |  $S = 0.25H$  | reflection values 70/50/20); luminous flux: 28.000lm; light colour: 840, colour temperature: 4000K, MacAdam  $\leq 2$  SDCM (initial), colour rendering: CRI > 80; luminous efficacy: 191lm/W; rated service life: 100.000h (L95) at AT= 25°C; control: DALI 2; for wired networking: open and standardized DALI2 interface enables full flexibility and future-proofing for changes in use or functional adaptation through individual programming; multi-sensor luminaire consisting of a DALI2 multi-sensor and DALI2 ECG; multi-sensor luminaire for wired connection to a DALI2 application controller (e.g., SITECO Connect 11 or 21); can also be connected to existing on-site lighting or building automation systems upon request; integrated DALI2 sensor certified according to IEC 62386, Parts 101, 103, 303, and 304; integrated DALI2 ECG provides luminaire data (according to IEC 62386, Part 251), energy data (Part 252), and monitoring and analytics data (Part 253) to higher-level systems for further processing; luminaire with PIR sensor (passive-infrared); with light sensor; luminaire connection: terminal, 5-pole, max. 2.5mm<sup>2</sup> (cable entry for one cable,  $\varnothing$  8.5..16mm); mains connection: 230..240V, AC 50/60Hz; connected load: 146,6W; protection rating (complete): IP65; insulation class (complete): insulation class I (protective earthing); protection symbol: D; certification: CE, UKCA; internal wiring halogen-free; luminaire Suitable for use in the food industry according to the specifications of IFS-Food, HACCP and/or BRC; LABS conformity tested according to VDMA 24364:2018-05; housing frame of high-performance plastic PA6, matt traffic white (RAL 9016); cover of PMMA; dimension (LxWxH): 474 x 442 x 72mm; permissible operating ambient temperature: -20..+35°C (reducing of maximum allowable ambient temperature of 5°C with ceiling mounting); packaging unit: 1 piece; (delivery without accessories; please order mounting accessories separately)



Lamps: LED  
 Wt. (kg): 3.7  
 GTIN (EAN): 4069025241269

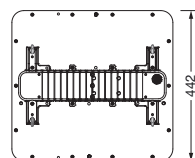
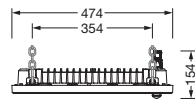

It is mandatory that the assembly instructions must be observed when planning and installing the electrical installation (to be found at [www.siteco.com](http://www.siteco.com))

Tolerances related to thermal, electrical and photometric data according to IEC 62722

Issued 20.03.2026 - Modifications and errors subject to change - Ensure that you always use the latest version -

**Order No.:** 51HN12DA4MDA03 | **GTIN (EAN):** 4069025241269

**Detailed technical description:** HB11md,wd,28000lm840,DA2,M-Sens



### Key data

- System family: SITECO Connect 11, SITECO Connect 21 O
- Product type: high bay luminaire
- Product name: Highbay 11 midi
- Order No.: 51HN12DA4MDA03

### Lighting technology | Lamps | Control gear

#### Component 1

#### Lighting technology:

- Light control: lens of PMMA
- Cover: cover
- Beam angle: wide distribution
- Symmetry: symmetric
- Light emission: direct distribution
- UGR viewing direction along longitudinal luminaire axis:  $\leq 22$
- UGR viewing direction along lateral luminaire axis:  $\leq 22$

#### Lamps:

- Lamps: with LED
- Rated luminous flux: 28000lm
- Luminous efficacy: 191lm/W
- Colour temperature: 4000K
- Colour rendering index: CRI > 80
- Light colour: 840
- SDCM (Standard Deviation of Colour Matching): MacAdam  $\leq 2$  SDCM (initial)
- Rated input power: 146.6W
- Supplement: internal wiring halogen-free

#### Operating device:

- Control: DALI 2, dimmable

#### Certificates, Standards

- Protection rating: IP65
- Insulation class: insulation class I (protective earthing)
- Protection symbol: D
- Temperature range (operation): -20..+35°C
- Supplement: LABS conformity tested according to VDMA 24364:2018-05, Suitable for use in the food industry according to the specifications of IFS-Food, HACCP and/or BRC
- Certification, designation: CE, UKCA

### Material, Colour

- housing frame: high-performance plastic PA6, matt traffic white (RAL 9016)
- Cover: cover of PMMA

### Mounting

- Mounting method, mounting location: suspended mounting, surface-mounted, to wire, to the ceiling, to the chain
- Mounting height: 5..17m
- Arrangement: single arrangement

### Electrical connection

- Connection: terminal, 5-pole, max. 2.5mm<sup>2</sup>
- Nominal voltage: 230..240V, 50/60Hz, AC

### Dimensions, Weight

- Length: 474mm
- Width: 442mm
- Height: 72mm
- Weight: 3.7kg

### Service life

- Rated service life: 100000h (L95) at AT = 25°C, 100000h (L90) at AT = ta max

### Inputs

#### PIR sensor (passive-infrared)

- Connection: motion sensor technology
- Detection angle: 360°
- Detection range: at mounting height (Mh) = 15m: tangential max.  $\varnothing 21m$  | at Mh = 7.5m: tangential max.  $\varnothing 10.5m$
- Feature: circular detection area

#### light sensor

- Connection: daylight sensor technology
- Detection angle: 60°
- Detection range: measuring range on the ground at mounting height (Mh) = 5m:  $\varnothing$  approx. 5.6m | at Mh = 6m:  $\varnothing$  approx. 6.8m
- Illuminance: 5..5000lx (measured at sensor)

### Outputs

#### DALI-2

- System current: max. 12mA

Order No.: 51HN12DA4MDA03 | GTIN (EAN): 4069025241269

Dimensions: HB11md,wd,28000lm840,DA2,M-Sens

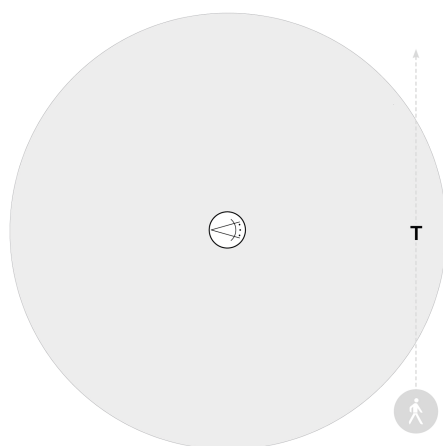
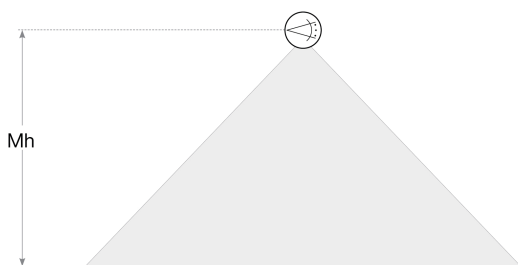
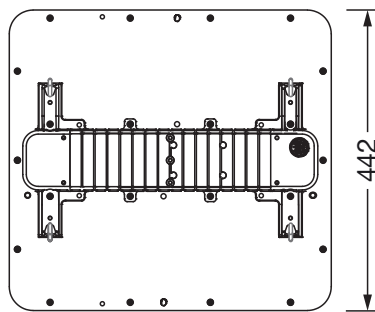
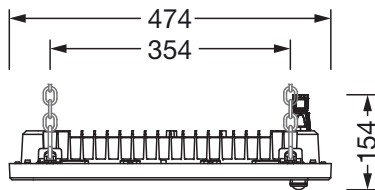

### Sensor PC 11

Mh	T
7,5m	ø = 10,5m
15m	ø = 21m

It is mandatory that the assembly instructions must be observed when planning and installing the electrical installation (to be found at [www.siteco.com](http://www.siteco.com))

Tolerances related to thermal, electrical and photometric data according to IEC 62722

Issued 20.03.2026 - Modifications and errors subject to change - Ensure that you always use the latest version -