

Order No.: 51HN11DA5KDA | **GTIN (EAN):** 4069025424136

Product description: HB11md,nrrw,22910lm850,DA2



high bay luminaire Highbay 11 midi; direct symmetric narrow distribution, light control with lens of PMMA; $UGR \leq 22$ ($X = 4H$ | $Y = 8H$ | $S = 0.25H$ | reflection values 70/50/20); luminous flux: 22.910lm; light colour: 850, colour temperature: 5000K, MacAdam ≤ 2 SDCM (initial), colour rendering: CRI > 80; luminous efficacy: 195,5lm/W; rated service life: 100.000h (L95) at AT= 25°C; control: DALI 2; luminaire connection: terminal, 5-pole, max. 2.5mm² (cable entry for one cable, \varnothing 8.5..16mm); mains connection: 230..240V, AC/DC 0/50..60Hz; connected load: 117,2W; protection rating (complete): IP66; insulation class (complete): insulation class I (protective earthing); protection symbol: D; impact resistance: IK08; certification: CE, ENEC, VDE, UKCA; luminaire for central battery installations according to EN 60598-2-22, internal wiring halogen-free; luminaire LABS conformity tested according to VDMA 24364:2018-05; Suitable for use in the food industry according to the specifications of IFS-Food, HACCP and/or BRC; housing frame of high-performance plastic PA6, matt traffic white (RAL 9016); cover of PMMA; dimension (LxWxH): 474 x 442 x 72mm; permissible operating ambient temperature: -40..+55°C (reducing of maximum allowable ambient temperature of 5°C with ceiling mounting); packaging unit: 1 piece; (delivery without accessories; please order mounting accessories separately)



Lamps:	LED
Wt. (kg):	3.7
GTIN (EAN):	4069025424136



Order No.: 51HN11DA5KDA | GTIN (EAN): 4069025424136

Detailed technical description: HB11md,nrrw,22910lm850,DA2



Key data

- Product type: high bay luminaire
- Product name: Highbay 11 midi
- Order No.: 51HN11DA5KDA

Lighting technology | Lamps | Control gear

Component 1

Lighting technology:

- Light control: lens of PMMA
- Cover: cover
- Beam angle: narrow distribution
- Symmetry: symmetric
- Light emission: direct distribution
- UGR viewing direction along longitudinal luminaire axis: ≤ 22
- UGR viewing direction along lateral luminaire axis: ≤ 22

Lamps:

- Lamps: with LED
- Rated luminous flux: 22910lm
- Luminous efficacy: 196lm/W
- Colour temperature: 5000K
- Colour rendering index: CRI > 80
- Light colour: 850
- SDCM (Standard Deviation of Colour Matching): MacAdam ≤ 2 SDCM (initial)
- Rated input power: 117.2W
- Supplement: internal wiring halogen-free

Operating device:

- Switching method: for central battery installations according to EN 60598-2-22

Component 2

Certificates, Standards

- Protection rating: IP66
- Insulation class: insulation class I (protective earthing)
- Impact resistance: IK08
- Protection symbol: D
- Temperature range (operation): -40..+55°C
- Supplement: LABS conformity tested according to VDMA 24364:2018-05, Suitable for use in the food industry according to the specifications of IFS-Food, HACCP and/or BRC
- Standard: EN 60598-2-22
- Certification, designation: CE, ENEC, VDE, UKCA

Material, Colour

- housing frame: high-performance plastic PA6, matt traffic white (RAL 9016)
- Cover: cover of PMMA

Mounting

- Mounting method, mounting location: suspended mounting, surface-mounted, to wire, to the ceiling, to the wall, to the chain
- Arrangement: single arrangement

Electrical connection

- Connection: terminal, 5-pole, max. 2.5mm²
- Nominal voltage: 230..240V, 0/50..60Hz, AC/DC

Dimensions, Weight

- Length: 474mm
- Width: 442mm
- Height: 72mm
- Weight: 3.7kg

Service life

- Rated service life: 100000h (L95) at AT = 25°C, 100000h (L90) at AT = ta max

Order No.: 51HN11DA5KDA | GTIN (EAN): 4069025424136

Dimensions: HB11md,nrrw,22910lm850,DA2

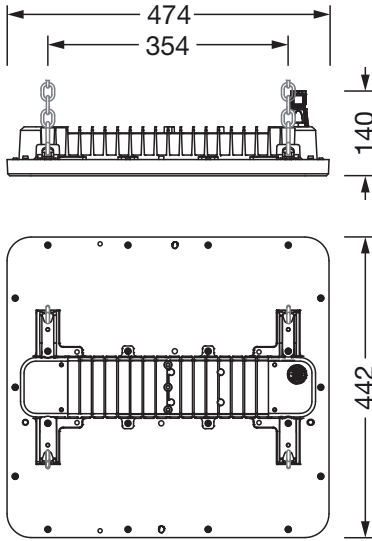

It is mandatory that the assembly instructions must be observed when planning and installing the electrical installation (to be found at www.siteco.com)

Tolerances related to thermal, electrical and photometric data according to IEC 62722

Issued 20.03.2026 - Modifications and errors subject to change - Ensure that you always use the latest version -