

Order No.: 51DC312MD4400A | **GTIN (EAN):** 4069025359261

Product description: Lun11R,surf,bk4140lm840,ML



Lunis 11 R, downlight, light control with reflector, highly specular, light emission: direct distribution, LED rated luminous flux: 4.140lm, light colour: 840, with terminal, 3-pole, max. 2.5mm², mains connection: 220..240V, AC, 50/60Hz, luminaire housing, of aluminium, black, diameter: 380mm, central ring, of plastic, black, central module, blanking cover, of sheet steel, perforated, white, protection rating (complete): IP20, insulation class (complete): insulation class I (protective earthing), certification: CE, permissible ambient temperature for indoor applications: ≤ +35°C, standard: EN 50419, packaging unit: 1 piece

IP 20  

Lamps: LED
 Wt. (kg): 2.0
 GTIN (EAN): 4069025359261

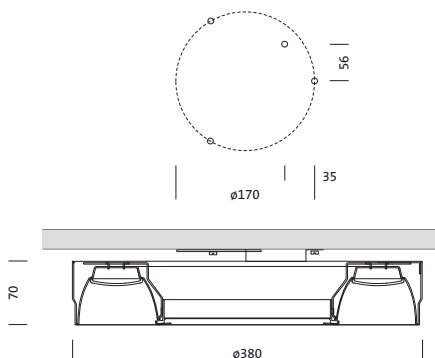

It is mandatory that the assembly instructions must be observed when planning and installing the electrical installation (to be found at www.siteco.com)

Tolerances related to thermal, electrical and photometric data according to IEC 62722

Issued 04.07.2025 - Modifications and errors subject to change - Ensure that you always use the latest version -

Order No.: 51DC312MD4400A | **GTIN (EAN):** 4069025359261

Detailed technical description: Lun11R,surf,bk4140lm840,ML



Key data

- Product type: downlight
- Product name: Lunis 11 R
- Order No.: 51DC312MD4400A

Lighting technology | Lamps | Control gear

Component 1

Lighting technology:

- Light control: reflector, highly specular
- Beam angle: wide distribution
- Symmetry: symmetric distribution
- Light emission: direct distribution

Lamps:

- Lamps: with LED
- Rated luminous flux: 4140lm
- Luminous efficacy: 164lm/W
- Colour temperature: 4000K
- Colour rendering index: CRI > 80
- Light colour: 840
- Rated input power: 25.3W

Operating device:

- Control: ON/OFF Multilumen

Certificates, Standards

- Protection rating: IP20
- Insulation class: insulation class I (protective earthing)
- Temperature range (operation): $\leq +35^{\circ}\text{C}$
- Standard: EN 50419
- Certification, designation: CE

Material, Colour

- luminaire housing: aluminium, black
- Quantity: 1 piece
- Colour specification: black
- central ring: plastic, black
- Quantity: 1 piece
- Colour specification: black
- central module, blanking cover: sheet steel, perforated, white
- Quantity: 1 piece
- Colour specification: white

Mounting

- Mounting method, mounting location: surface-mounted, to the ceiling

Electrical connection

- Connection: terminal, 3-pole, max. 2.5mm²
- Nominal voltage: 220..240V, 230..240V, 50/60Hz, AC

Dimensions, Weight

- Diameter: 380mm
- Weight: 2.0kg

Order No.: 51DC312MD4400A | GTIN (EAN): 4069025359261

Dimensions: Lun11R,surf,bk4140lm840,ML

