

Order No.: 51SL64MB11A2C | **GTIN (EAN):** 4069025502735

Product description: LicSp21,wd,2600lm927,ML,sr



Licross Spot 21, directional spotlight, light control with reflector, of aluminium, optical cover: cover panel, of glass, beam angle: wide distribution, LED rated luminous flux: 2.600lm, light colour: 927, with plug, 3-pole, with phase selection, mains connection: 220..240V, AC, 50/60Hz, of aluminium, metallic grey (RAL 9006), length: 300mm, diameter: 90mm, decorative ring, of PC, metallic grey (RAL 9006), protection rating (complete): IP20, insulation class (complete): insulation class II (safety insulation), certification: CE, impact resistance: IK02, permissible ambient temperature for indoor applications: -20..+25°C, packaging unit: 1 piece

IP 20  

Lamps:	LED
Wt. (kg):	0.8
GTIN (EAN):	4069025502735



Order No.: 51SL64MB11A2C | **GTIN (EAN):** 4069025502735

Detailed technical description: LicSp21,wd,2600lm927,ML,sr



Key data

- Product type: directional spotlight
- Product name: Licross Spot 21
- Order No.: 51SL64MB11A2C

Lighting technology | Lamps | Control gear

Component 1

Lighting technology:

- Light control: reflector of aluminium
- Cover: cover panel
- Beam angle: wide distribution
- Symmetry: symmetric

Lamps:

- Lamps: with LED
- Rated luminous flux: 2600lm
- Luminous efficacy: 140lm/W
- Colour temperature: 2700K
- Colour rendering index: CRI > 90
- Light colour: 927
- SDCM (Standard Deviation of Colour Matching): MacAdam \leq 2 SDCM (initial)
- Rated input power: 18.5W
- Supplement: luminous flux adjustable on luminaire in 8 steps (1870/.../3500lm), connected load according to luminous flux setting (12.9/.../26.5W)

Operating device:

- Control: ON/OFF Multilumen

Certificates, Standards

- Protection rating: IP20
- Insulation class: insulation class II (safety insulation)
- Impact resistance: IK02
- Temperature range (operation): -20...+25°C
- Certification, designation: CE

Material, Colour

- decorative ring: PC, metallic grey (RAL 9006)
- Cover: cover panel of glass

Mounting

- Mounting method, mounting location: slip-in mounting, in the Licross trunking rail

Electrical connection

- Connection: plug, 3-pole, with phase selection
- Nominal voltage: 220...240V, 50/60Hz, AC

Dimensions, Weight

- Length: 300mm
- Diameter: 90mm
- Weight: 0.8kg

Service life

- Rated service life: 50000h (L90/B10) at AT = 25°C

Order No.: 51SL64MB11A2C | GTIN (EAN): 4069025502735

Dimensions: LicSp21,wd,2600lm927,ML,sr

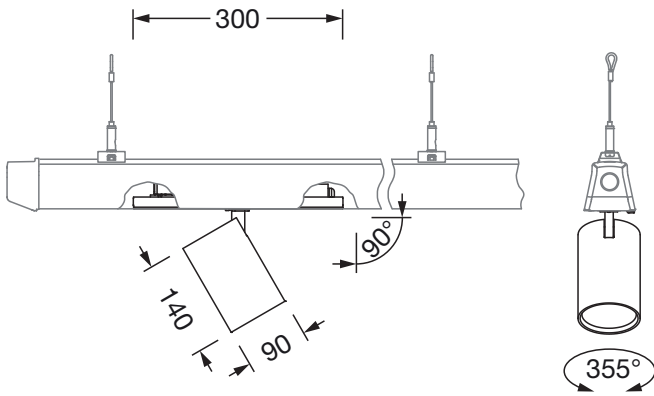

It is mandatory that the assembly instructions must be observed when planning and installing the electrical installation (to be found at www.siteco.com)
Tolerances related to thermal, electrical and photometric data according to IEC 62722
Issued 27.02.2026 - Modifications and errors subject to change - Ensure that you always use the latest version -