

sITeCO



Now with SITECO iQ
Smart-Interface

(Zhaga-D4i standard)



Types,
data sheets,
configuration –
all at a glance:

**Streetlight
SL 21 iQ**



Streetlight SL 21 iQ

Maximum flexible light.



Light for today. And tomorrow. **Maximum flexibility.**

More flexible than ever: Streetlight SL 21 with SITECO iQ offers you a whole range of functions that allow you to save energy and enjoy convenience today. And in combination with Zhaga-D4i interface, you keep your options open for the future: Wireless radio control, full connectivity or sensor technology – everything is possible. Additionally, the NEMA interface allows you to connect a variety of control and sensor options.

Streetlight SL 21 – more flexible than ever.



A relaxed tomorrow – with smart municipal administration:
Streetlight SL 21 iQ & luxData



● **Maximum flexibility:**

- Connectivity & sensor technology with NEMA or Zhaga-D4i interfaces
- Intelligent lighting control options with SITECO iQ

● **Sustainable and insect-friendly:**

- Various light distributions thanks to lens-based, high-power LED technology – with 0 % light pollution at 0° tilt

● **Grows with your requirements:**

- Accessories for shielding light can be attached subsequently to the mast (on the side, rear and / or front)

● **Simple assembly and adjustment:**

- Tool-free opening
- Tool-free mast flange assembly on the luminaire
- Tool-free tilt adjustment for quick installation and alignment (optional: universal mast flange)

● **Simple maintenance:**

- Luminaire design without cooling ribs prevents dirt accumulation and simplifies cleaning
- Screwless attachment of the glass cover for quick replacement directly on the mast or for easily retrofitting the lighting technology plus accessories



Tool-free closure system for easy and quick installation and maintenance. The closure system is positioned on the back to prevent dirt accumulation. When opened, the power supply is interrupted.

Integrated white reflector to reduce internal reflections and **maximize light output**.

Simple component exchange on the mast thanks to a connector between the ECG and LED module for ESD-safe maintenance (versions with iQ and Smart-Interface).

Multi-level, silicone-free seal, **replaceable without causing damage**.

Integrated ESD protection from damage due to static charges for mounting on non-conductive masts and support systems (e. g. wooden masts).

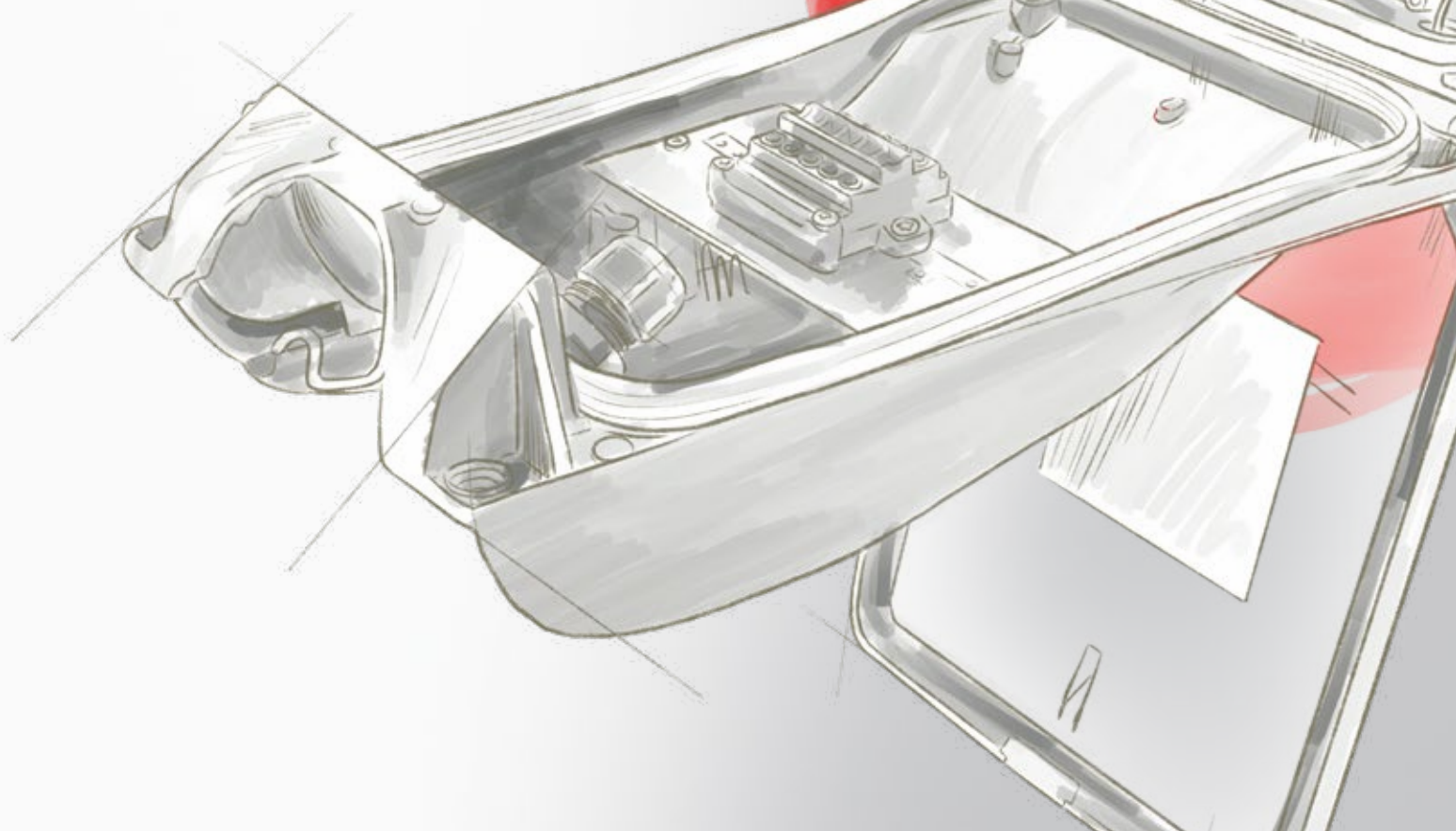

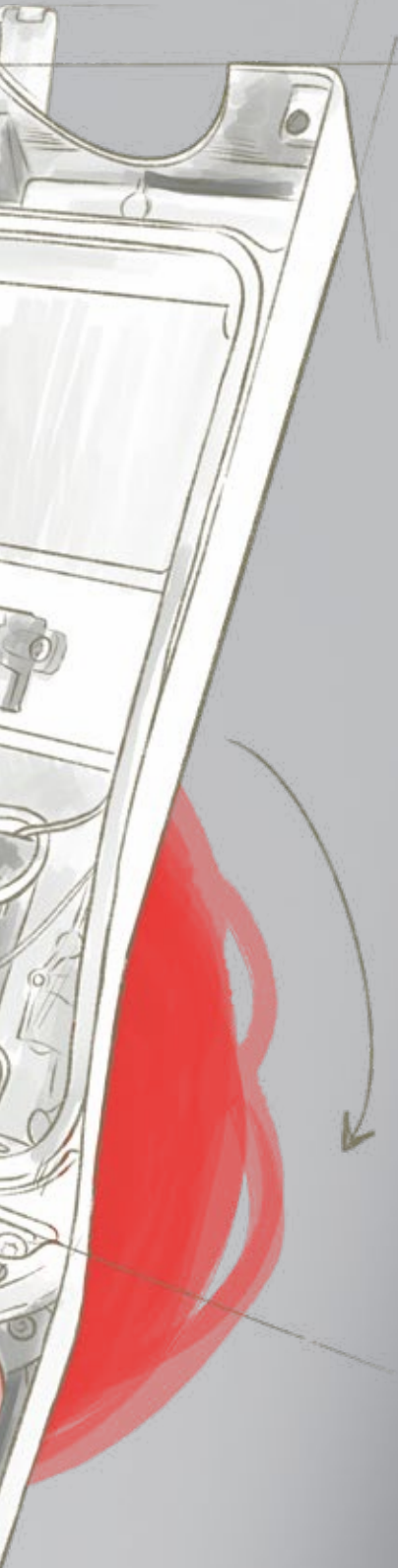

Complex lighting is just this simple.

Two assemblies. Easy and convenient handling.

Retrofittable BLC covers integrated in the LED module (Back Light Control) and other accessories to prevent any light spill.

Back Light Control cover (BLC): To reduce rearward light spill, the integrated BLC cover can be retrofitted at any time without affecting the luminaire's design.

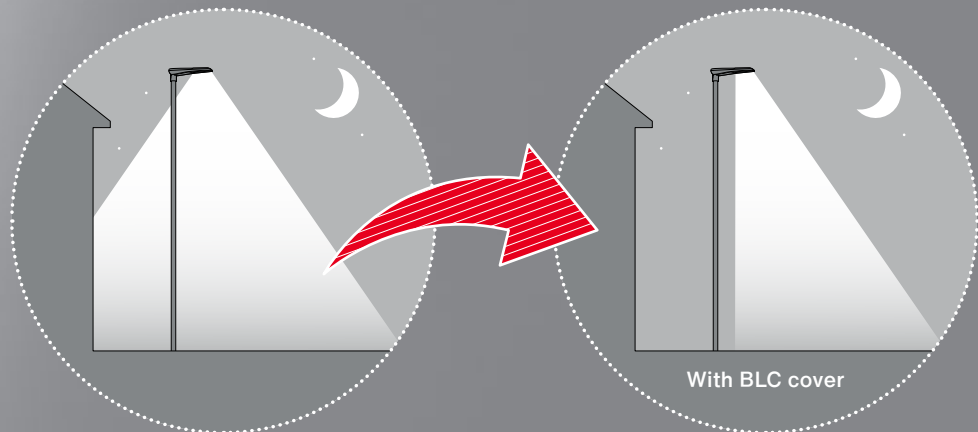

Light: intelligent. Control: intuitive. Future: on board.

Learn more
about the
iQ functions
here:



Comprehensive control and diagnostic options?
Or interfaces for sensor technology and the like?

Both, of course!

Smart-Interface complies with the Zhaga-D4i standard, which means it is standardized according to Zhaga Book 18. Your benefit? 100 % compatibility of wireless accessories and sensors.

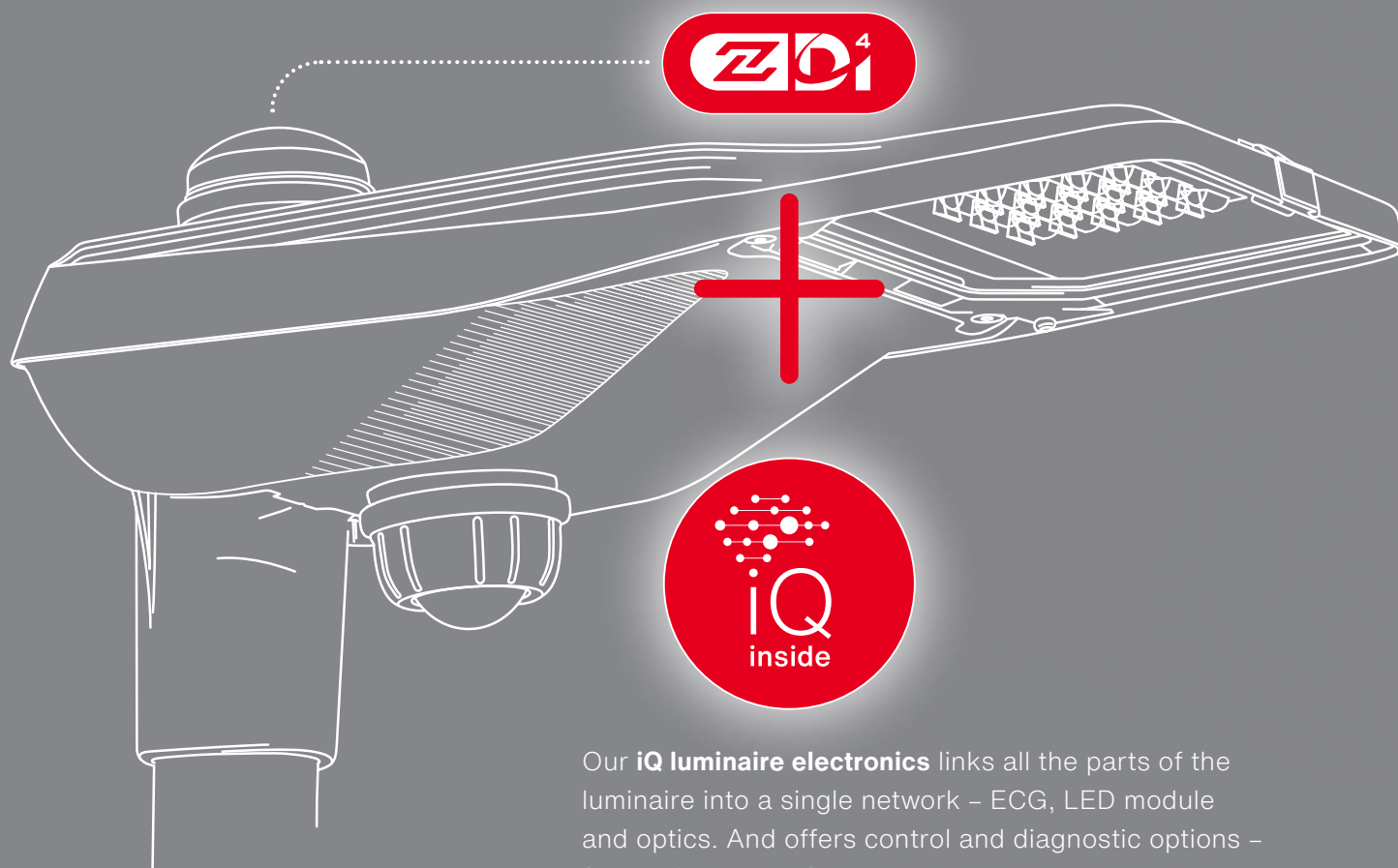

Our **iQ luminaire electronics** links all the parts of the luminaire into a single network – ECG, LED module and optics. And offers control and diagnostic options – for maximum comfort.

NEMA or Zhaga? SL 21 offers both!

The NEMA interface (7pin) complies with the ANSI standard, which means, wireless accessories and sensors are 100 % compatible.

Please note: To use SITECO iQ, you need the Smart-Interface (Zhaga-D4i).

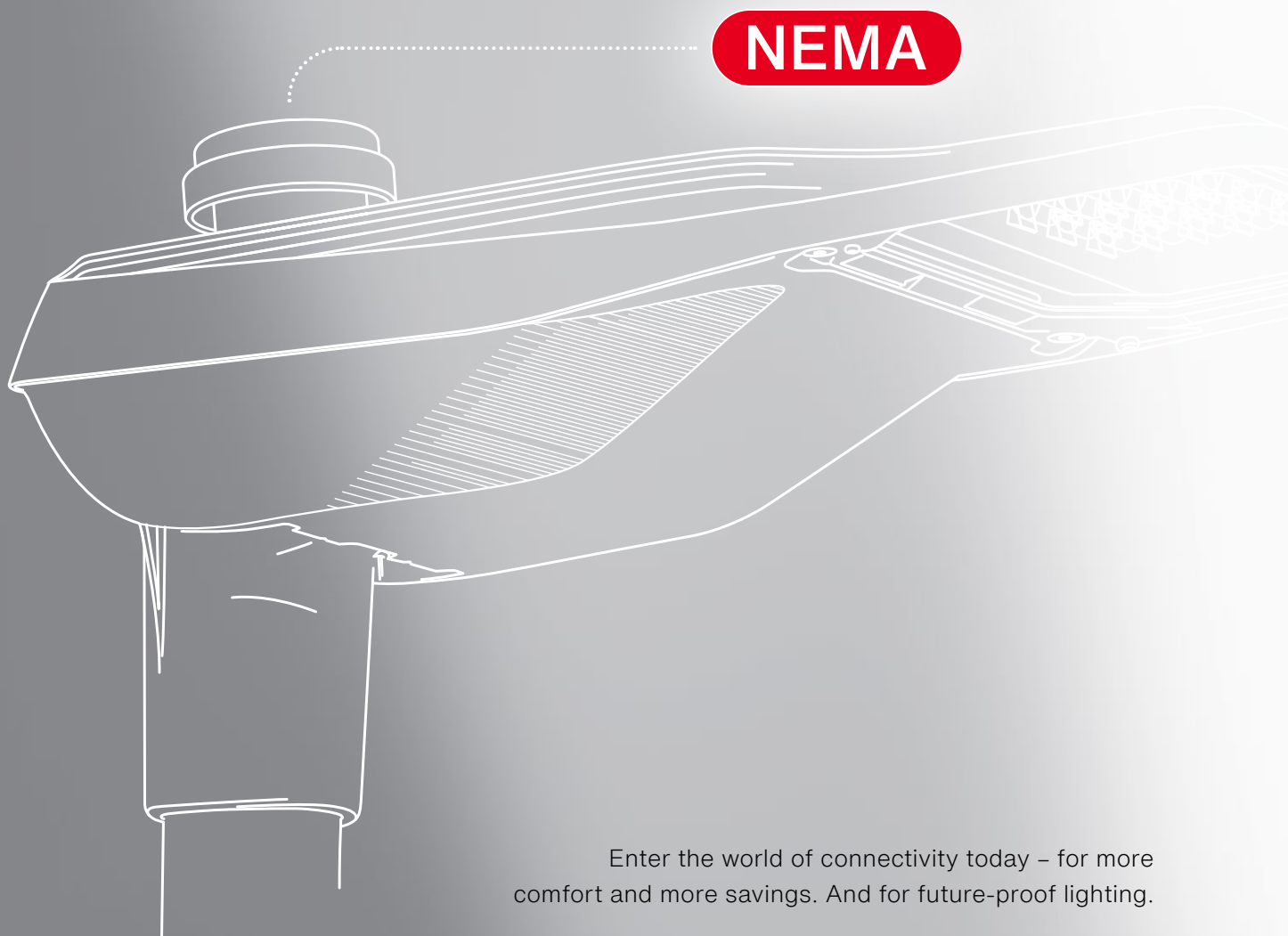

Enter the world of connectivity today – for more comfort and more savings. And for future-proof lighting.

SITECO iQ

Because we know
what challenges you
are facing every day.

Learn more
about the
iQ functions
here:

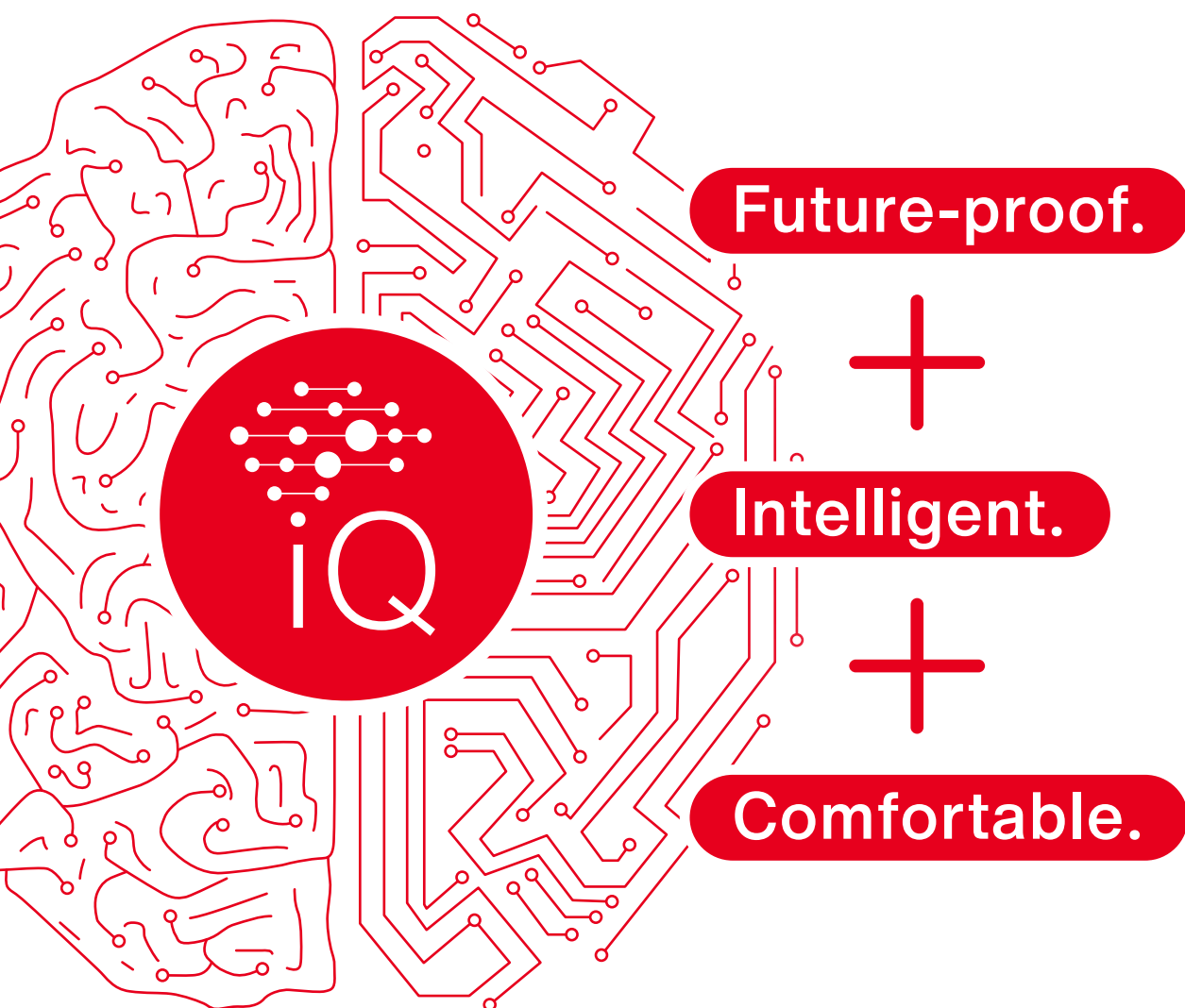

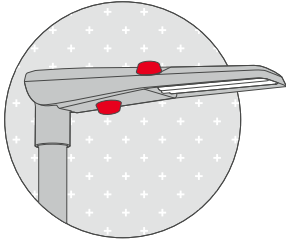

Smart-Interface

Intelligent light at its peak – for maximum future viability.

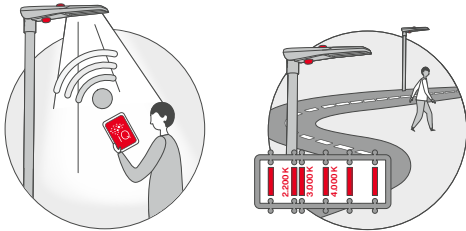

Street-Remote

Colour-Switch

Intelligent additional features – for maximum flexibility.

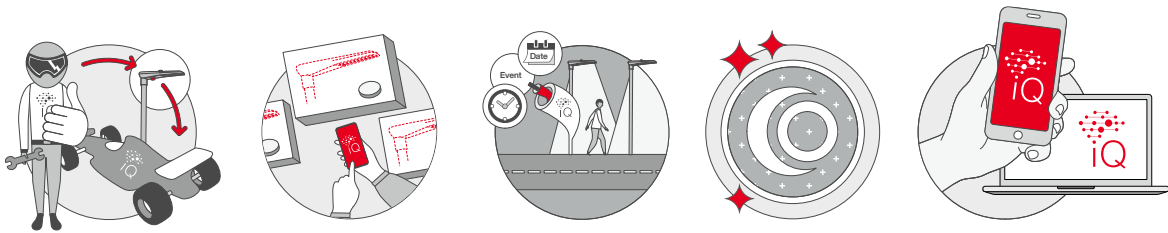

Auto-Match

Desk-Remote

Smart-Wire

Night-Set

iQ App & Webtool

Intelligent features – for maximum convenience in everyday use.

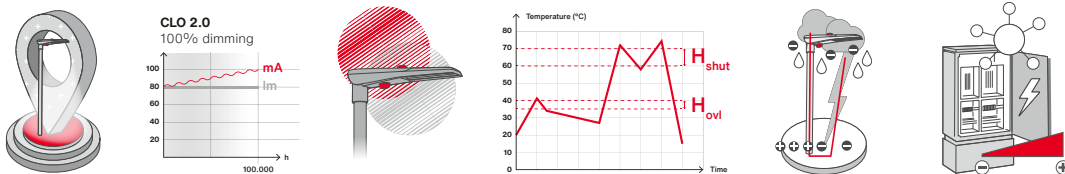

Lumen-Switch

CLO 2.0

Light-Fading

Temp-Guard

Surge Protection

Fuse-Plus

Intelligent foundation – for maximum efficiency.

Typically iQ.

Smart features
in detail.

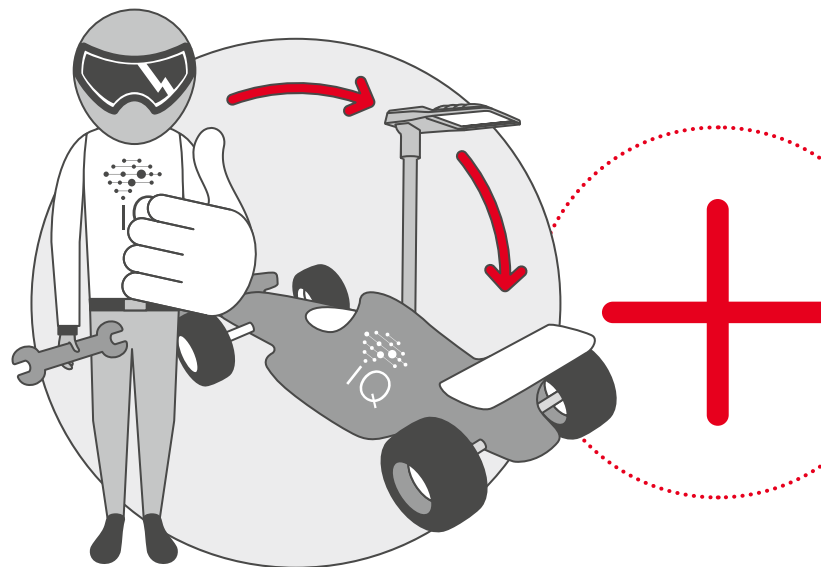

SITECO iQ Auto-Match

Exchanging components at Formula 1 speed.

In need of spare parts? That's always a hassle.
But with SITECO Auto-Match, you can stay relaxed.

In SITECO iQ luminaires, all components are connected.
You have to add a new ECG or LED board? No problem!
With Auto-Match, all data and settings from the existing
system are being automatically transferred.
Fast, simple, effortless.

That's iQ.

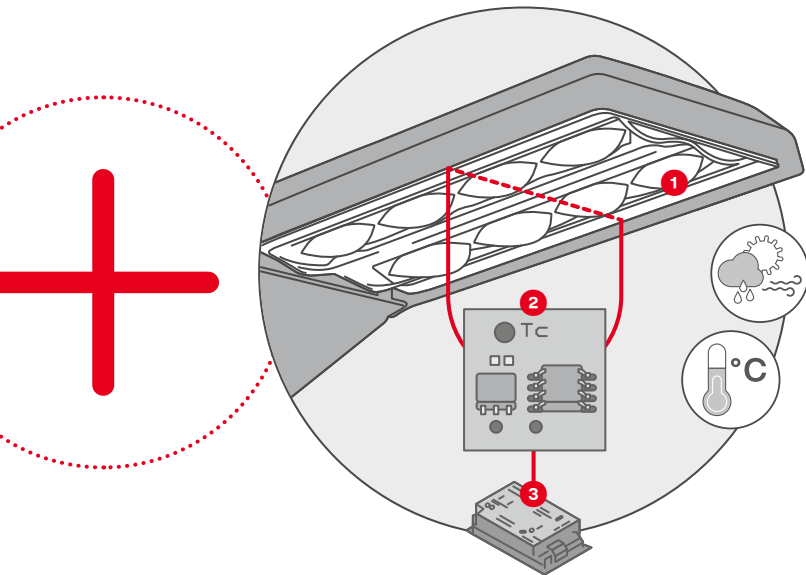

1

Wind? Rain? Hot or cold temperatures? Dimming?
All these factors influence the luminous flux of a luminaire.

2

Everything under control with CLO 2.0: A sensor installed in the luminaire measures the temperature of the LED and provides important diagnostic data.

3

The ECG is the control center. Based on the data provided, the ECG decides how much power is needed to achieve the specified luminous flux. The result: a demand-based power supply and thus **a reduction in energy consumption of up to 7 %!**

SITECO iQ CLO 2.0

Minimal energy use – automatically.

Depending on external influences, LEDs need more or less power for a certain luminous flux. The problem is: Ordinary LED luminaires do not measure outside temperature. As a consequence, on many days, the luminous flux is higher than necessary – a pure waste of energy.

SITECO CLO 2.0 regulates the power supply based on the actual ambient conditions. The result: 100 % constant light with minimum energy consumption. Savings potential: up to 7 %!

That's iQ.

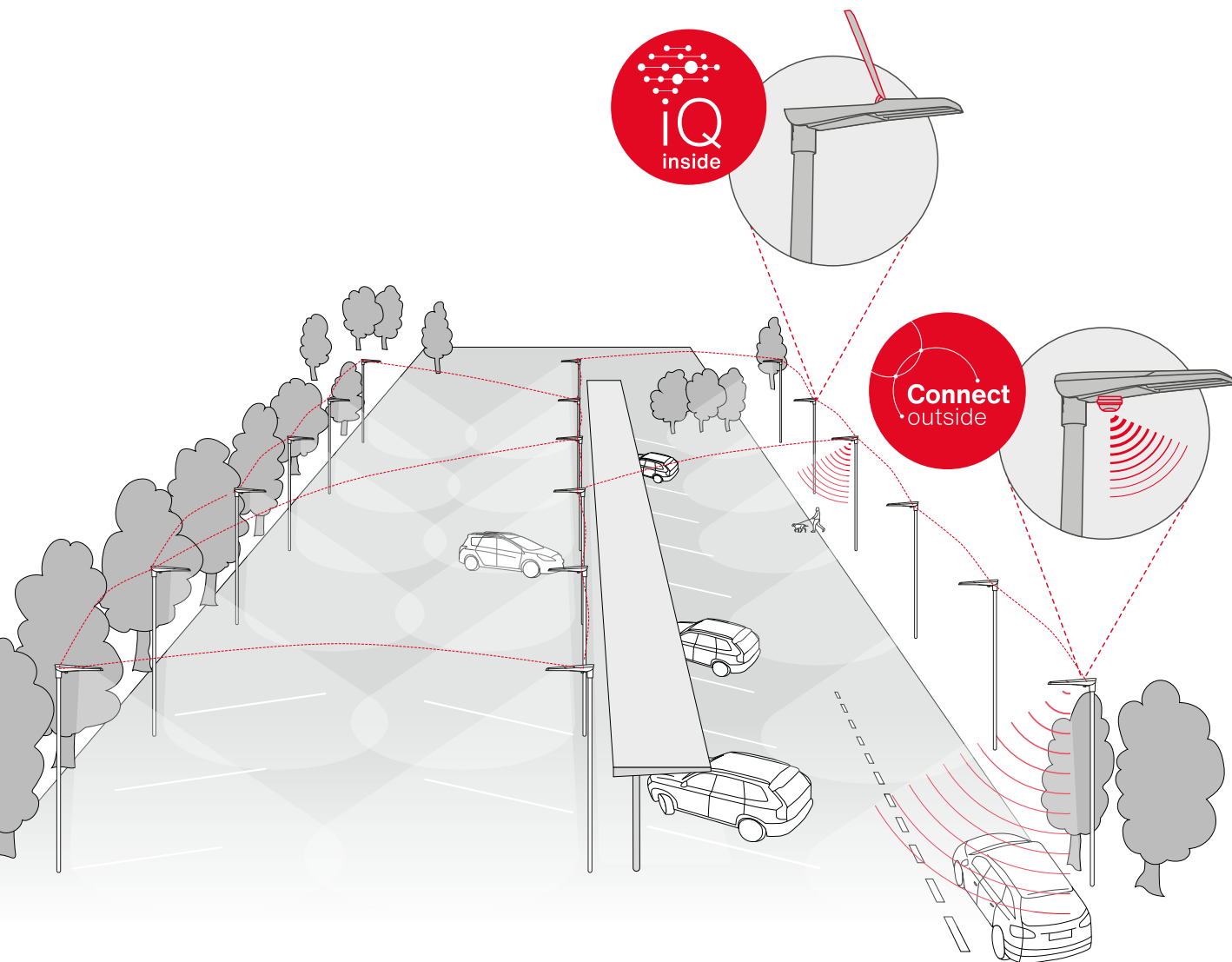

100 % flexibility. Step-by-step.

SITECO iQ luminaire electronics already offer countless functions to make life easier and energy savings greater. The SL 21 also comes with Smart-Interface and NEMA-Interface. Which lets you connect many wireless control systems and sensors through plug and play.

If and when you take this step is up to you – a decision you can make completely flexibly. Of course you can remain in the SITECO world for sensor technology and networking: We offer our own compatible control system with SITECO Connect.

From a single luminaire to a fully networked system.

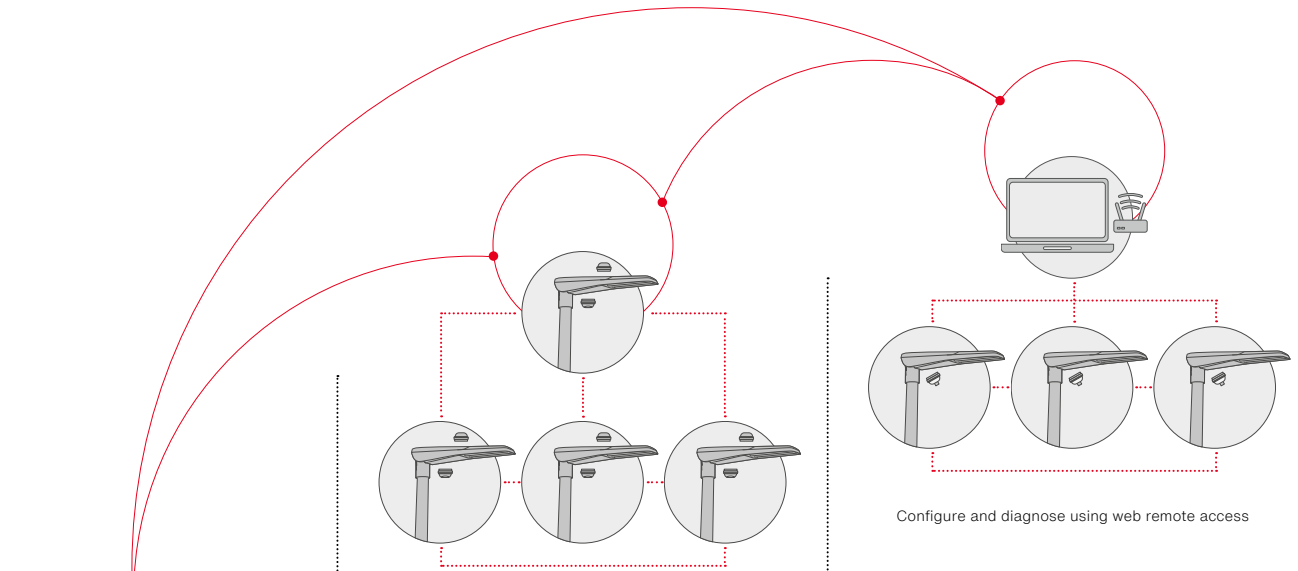

Configure and diagnose on-site with a USB transmitter on a laptop

Configure and diagnose using web remote access

SITECO Connect 31:
Individual luminaires

- Individual luminaires are switched or dimmed, e. g. with a local motion sensor.

SITECO Connect 21:
Several luminaires connected locally

- Several luminaires are connected via radio.
- The luminaires in the network communicate and synchronize among themselves.
- The luminaires are synchronously or successively switched or dimmed.

SITECO Connect 11:
Several luminaires connected with remote access

- The luminaires are connected via radio.
- Settings can be defined from the office through the network with remote access and status messages sent automatically.
- Existing inventory and workflow systems like luxData by sixData can be used as a master.

Advantages with modern lighting control



Increases traffic and personal safety, reduces vandalism.



Contributes to sustainability by protecting environmental resources and wildlife



Improves energy efficiency thanks to needs-based dimming

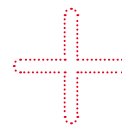

Optimizes operational management using current diagnostic data and documented systems

“Made in Germany” We’re living it!

“Made in Germany” is more than just a label for us. We have our own lens production and paint shop at our Traunreut facility as well as an in-house LED board production. We are constantly expanding our on-site production. This allows us to generate high added value in the region. And it means that we can guarantee you optimum quality and delivery capacity and respond quickly and flexibly to your individual requests and requirements.

We don’t just market “Made in Germany”. We embody it.



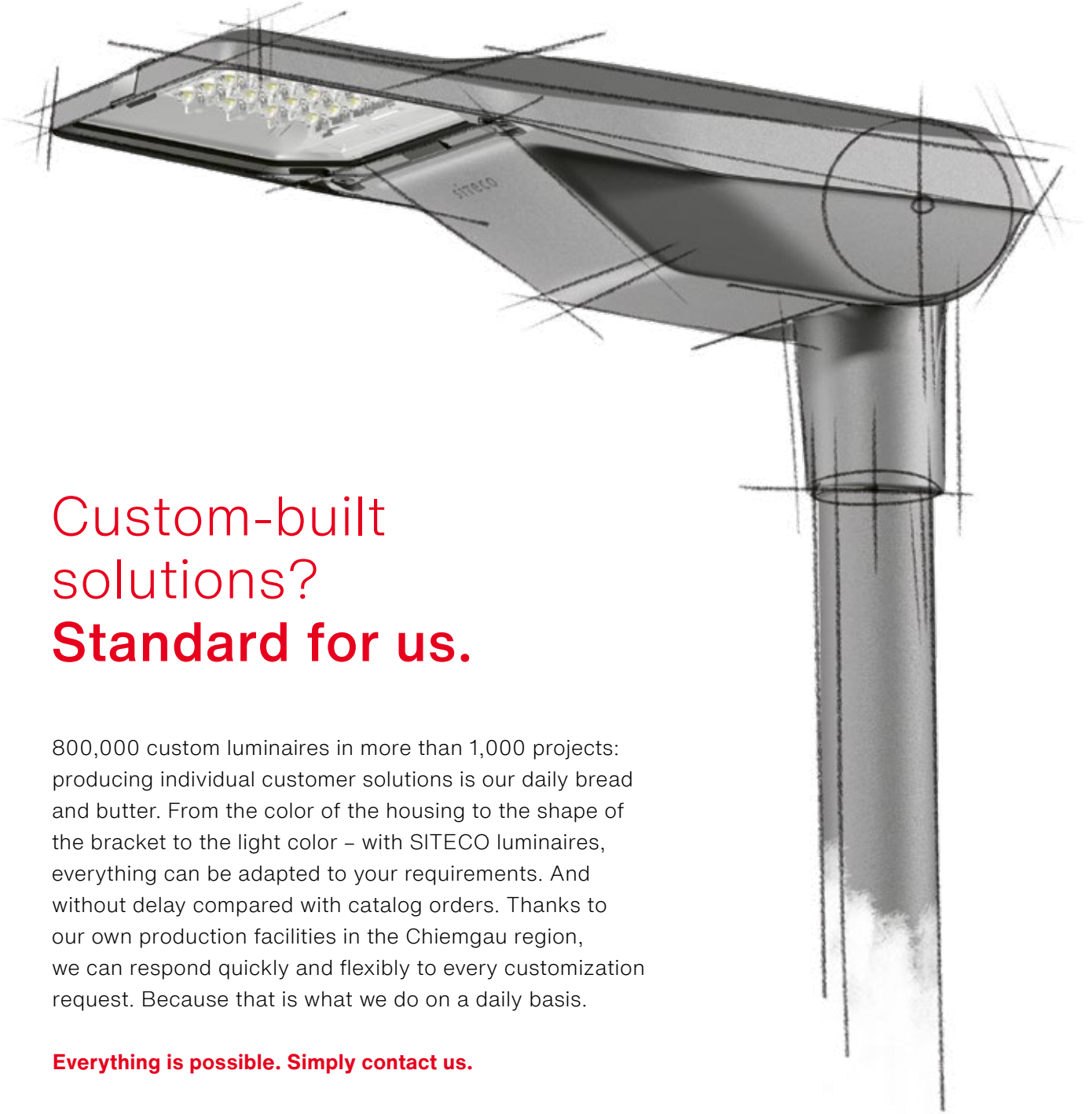

Custom-built solutions? **Standard for us.**

800,000 custom luminaires in more than 1,000 projects: producing individual customer solutions is our daily bread and butter. From the color of the housing to the shape of the bracket to the light color – with SITECO luminaires, everything can be adapted to your requirements. And without delay compared with catalog orders. Thanks to our own production facilities in the Chiemgau region, we can respond quickly and flexibly to every customization request. Because that is what we do on a daily basis.

Everything is possible. Simply contact us.

SITECO offers:

Zero light pollution

Zero percent light in the upper atmosphere is our goal. And this is exactly what Streetlight SL 21 achieves, thanks to its construction and lighting technology. For a truly **dark night sky**.

At SITECO, everything is designed for **long-lasting operation and significant CO₂ savings**. We therefore invest significant time and a lot of passion into developing sophisticated spare part concepts – across multiple luminaire generations.

SITECO offers:

Sustainable light

SITECO offers:

Future-proof and convenient maintenance

Modules, drivers and other components can be exchanged effortlessly. Repairs and upgrades can therefore be carried out in no time – and now even faster with iQ. **SITECO is light for generations**.

SITECO luminaires can be dimmed, switched and controlled as needed. The reduced level of light has a positive effect on the **natural behavior of animals**. This will be even easier in the future with iQ.

SITECO offers:

Precise lighting control

SITECO offers:

Sustainable and local value creation

We have our own in-house production facilities in Traunreut. Not only does this **benefit the environment, but also strengthens the location in the long term**.

SITECO offers:

Separation by type

The primary components are neither bonded nor fastened with screws. They can be easily separated and **returned to the material life cycle** – also because all materials are fully documented.

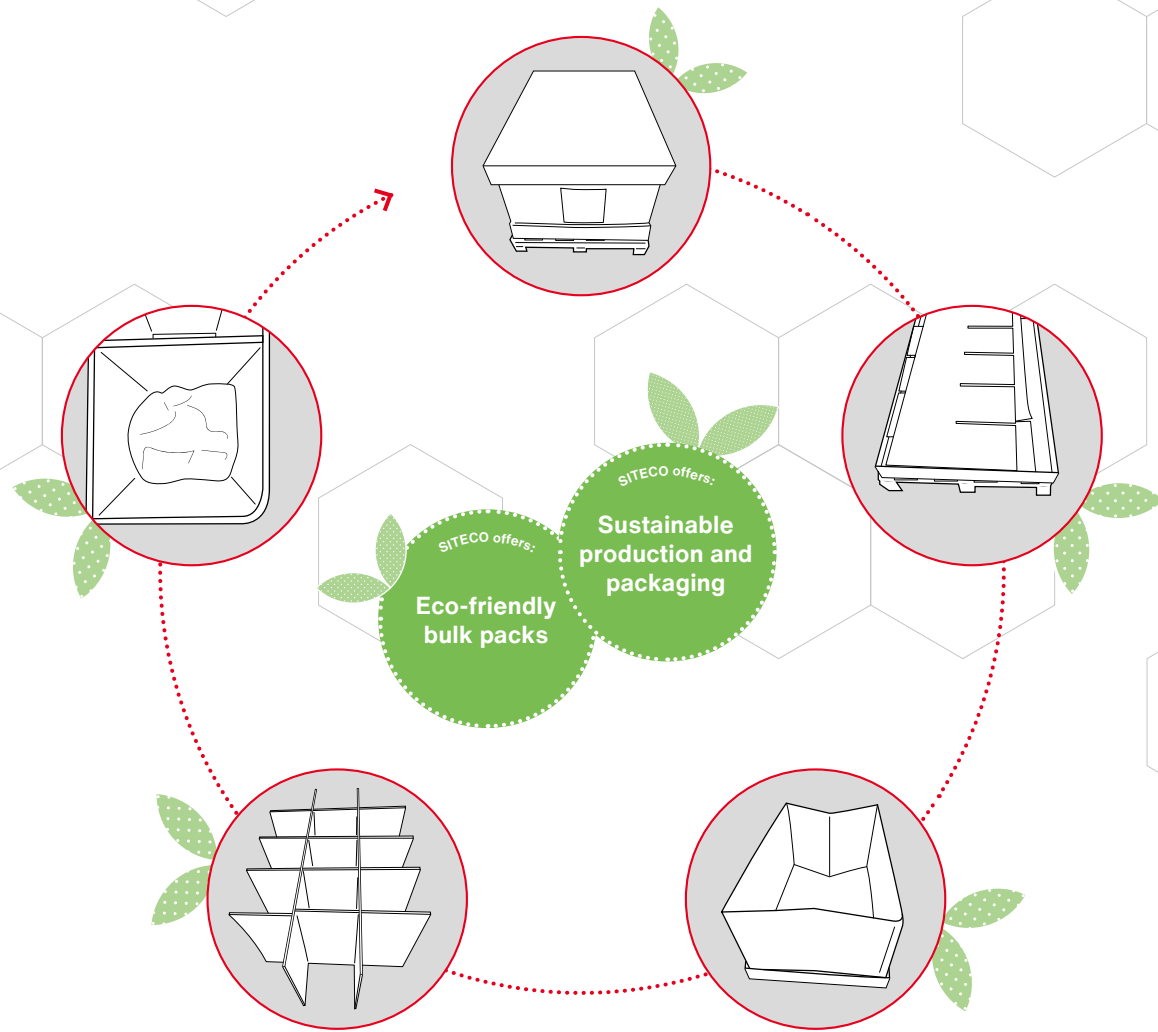

Being future-proof means being sustainable. In each and every aspect.

Sustainability is more than a trend – it is our collective responsibility. Systematic sustainability in all aspects is the only way to safeguard the future of our planet. This basic principle is the foundation for development, production and sales at SITECO. In our view, a true circular economy involves the entire product: Production that respects environmental protection guidelines. Durable design that allows upgrades. 100 % needs-based lighting. Eco-friendly, plastic-free and multiple-item packaging. And at the end: separating all materials by type.

Sustainability means anticipating the future.

Streetlight SL 21 models



Streetlight SL 21 micro

Technical data

Luminous flux: from 1,500 to 5,320 lm

Power consumption: up to 39 W

Luminous efficacy: up to 154 lm/W

Service life: above L97 after 100,000 h

Mounting heights: 3 to 6 m

Applications

Collection roads, cycle paths

Light distribution

1 2 3 4 5 6 7 8 9 10 (see diagram below)

Optical concept

Lens technology (PMMA)

Tilt options from -15° to $+15^\circ$

Light colors

2,200 K | 2,700 K | 3,000 K | 4,000 K

Color rendering: CRI > 70 / CRI > 80 at 3,000 K

Luminous intensity classes: G3 | G4 | G6

Type of protection

IP66

Safety class: II

Impact resistance: IK10

Mounting

Post-top / side entry

Mast flange: $\varnothing 76 / 60$ mm (post-top / side-entry),
 $\varnothing 60 / 48$ mm (post-top / side-entry), $\varnothing 42$ mm (side-entry)

Reducer: 76 – 60 mm, 76 – 42 mm

Control

SITECO iQ | SITECO iQ Street-Remote |

SITECO iQ Color-Switch | Smart-Interface (D4i) | NEMA (7pin)

Light distributions for Streetlight SL 21 models:

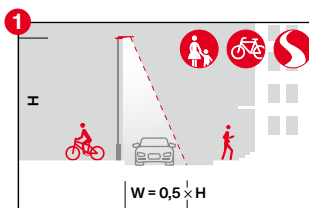

ST0.5a – For normal / narrow roads; lighting classes M + P; e. g., (cycle) paths, roads in residential areas

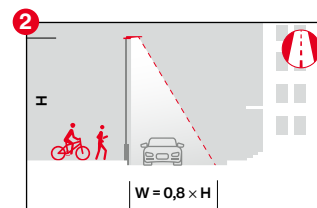

ST0.8a – For normal / wide roads; lighting classes M + P; e. g., collector roads, residential roads

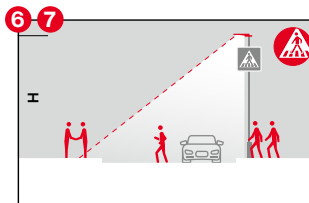

PC-L / R – For pedestrian crossings

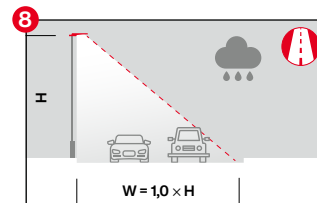

STW1.0a – Especially for wet streets and G4 requirements (e. g., conflict zones)



Streetlight SL 21 mini

Technical data

Luminous flux: from 3,723 to 13,390 lm
 Power consumption: up to 88 W
 Luminous efficacy: up to 160 lm/W
 Service life: above L97 after 100,000 h
 Mounting heights: 4 to 10 m

Applications

Collection roads, cycle paths, town plazas

Light distribution

1 2 3 4 5 6 7 8 9 10 (see diagram below)



Streetlight SL 21 midi

Technical data

Luminous flux: from 10,450 to 24,250 lm
 Power consumption: up to 155 W
 Luminous efficacy: up to 157 lm/W
 Service life: above L97 after 100,000 h
 Mounting heights: 6 to 14 m

Applications

Collection roads, cycle paths, plazas, conflict zones

Light distribution

1 2 3 4 5 6 7 8 9 10 (see diagram below)

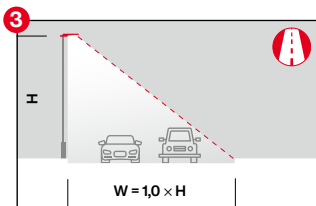

ST1.0a – For normal roads; lighting class M; e. g., main roads; optional with BLC

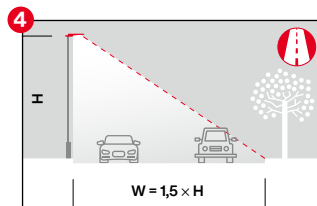

ST1.5a – For very wide roads; lighting class M; e. g., roads with abutting areas, car parks

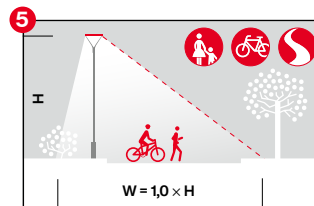

P1.0a – For narrow roads, pedestrian paths, residential roads; lighting class P

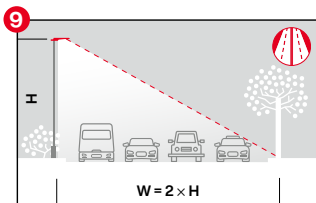

PL52 – For high mounting heights, e. g., industrial areas and car parks

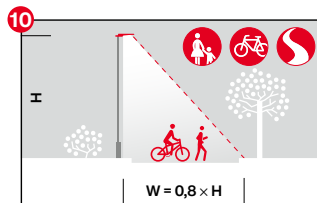

P0.8a – For narrow roads; e. g., residential roads, pedestrian paths; lighting class P

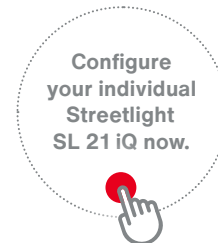

Sales.

Australia

SITECO UK Ltd
Hexagon Tower,
Crumpsall Vale, Blackley
Manchester, M9 8GQ
Phone +44 3300 555 209
contact-uk@siteco.com

Czech Republic

Siteco GmbH
contact-cz@siteco.com

Hungary

Siteco GmbH
contact-hu@siteco.com

New Zealand

SITECO UK Ltd
Hexagon Tower,
Crumpsall Vale, Blackley
Manchester, M9 8GQ
Phone +44 3300 555 209
contact-uk@siteco.com

Romania

SITECO Romania
Andreea Luppa
Phone: +40 735 316 760
a.luppa@siteco.eu

Spain

SITECO Lighting Spain, S.L.
Av. Leonardo da Vinci 15
28906 Madrid
Phone +34 9100 29095
contact-ES@siteco.com

Benelux

SITECO Benelux
Marten Meesweg 8-10
NL-3068 AV Rotterdam
Phone +31 85 4000 454
contact-nl@siteco.com

Finland

SITECO GmbH, Finnish Branch
Business Park Kehämylly
Vantaankoskentie 14
01670 VANTAA
contact-fi@siteco.com

Italy

SITECO Italy S.r.l.
Via Libero Temolo, 4
20126 Milan
Phone +39 320 0692561
contact-it@siteco.com

Norway

SITECO Norway AS
Engebrets vei 5
0275 Oslo
Phone +47 45 37 71 00
kundesenter@siteco.com

Serbia

SITECO Serbia
Ivan Lazarevic
Dositejeva 1a
11 000 Belgrad
Phone: +381 69 5444 802
i.lazarevic@siteco.com

Sweden

SITECO Sweden AB
Källbäckstrydsgatan 3
507 42 Borås
Phone +46 8128 70 422
contact-se@siteco.com

Bulgaria

SITECO Bulgaria
Andreea Luppa
Phone +40 735 316 760
a.luppa@siteco.eu

France

SITECO France Chez REGUS
7 rue Meyerbeen
75009 Paris
Phone +33 6 24 57 58 61
contact-fr@siteco.com

Moldova

SITECO Moldova
Andreea Luppa
Phone +40 735 316 760
a.luppa@siteco.eu

Poland

SITECO Poland Sp.z o.o.
Al. Jerozolimskie 94
00-807 Warszawa
Phone +48 22 462 49 30
contact-pl@siteco.pl

Slovakia

SITECO GmbH
Michael Bugar
Phone +421 904 266 999
contact-svk@siteco.com

United Kingdom

SITECO UK Ltd
Hexagon Tower,
Crumpsall Vale, Blackley
Manchester, M9 8GQ
Phone +44 3300 555 209
contact-uk@siteco.com

Croatia

SITECO Croatia
contact-hr@siteco.com

GCC Countries

SITECO UK Ltd
Hexagon Tower,
Crumpsall Vale, Blackley
Manchester, M9 8GQ
Phone +44 3300 555 209
contact-uk@siteco.com

Montenegro

SITECO Montenegro
Miomir Milacic
Phone +382 67 674 876
m.milacic-ext@siteco.com

Portugal

SITECO Portugal
Cesar Campos
Phone +351 91 171 44 85
contact-pt@siteco.com

Slovenia

SITECO GmbH
Georg-Simon-Ohm-Straße 50
83301 Traunreut, Nemičija
Phone +386 51 373615
contact-si@siteco.si

Other Countries

SITECO GmbH
Georg-Simon-Ohm-Straße 50
83301 Traunreut, Germany
contact-export@siteco.com

Contact.

Siteco GmbH

Georg-Simon-Ohm-Str. 50
83301 Traunreut, Germany
Phone +49 8669 330
info@siteco.com

siteco.com