

sITeCO

Made in
Traunreut

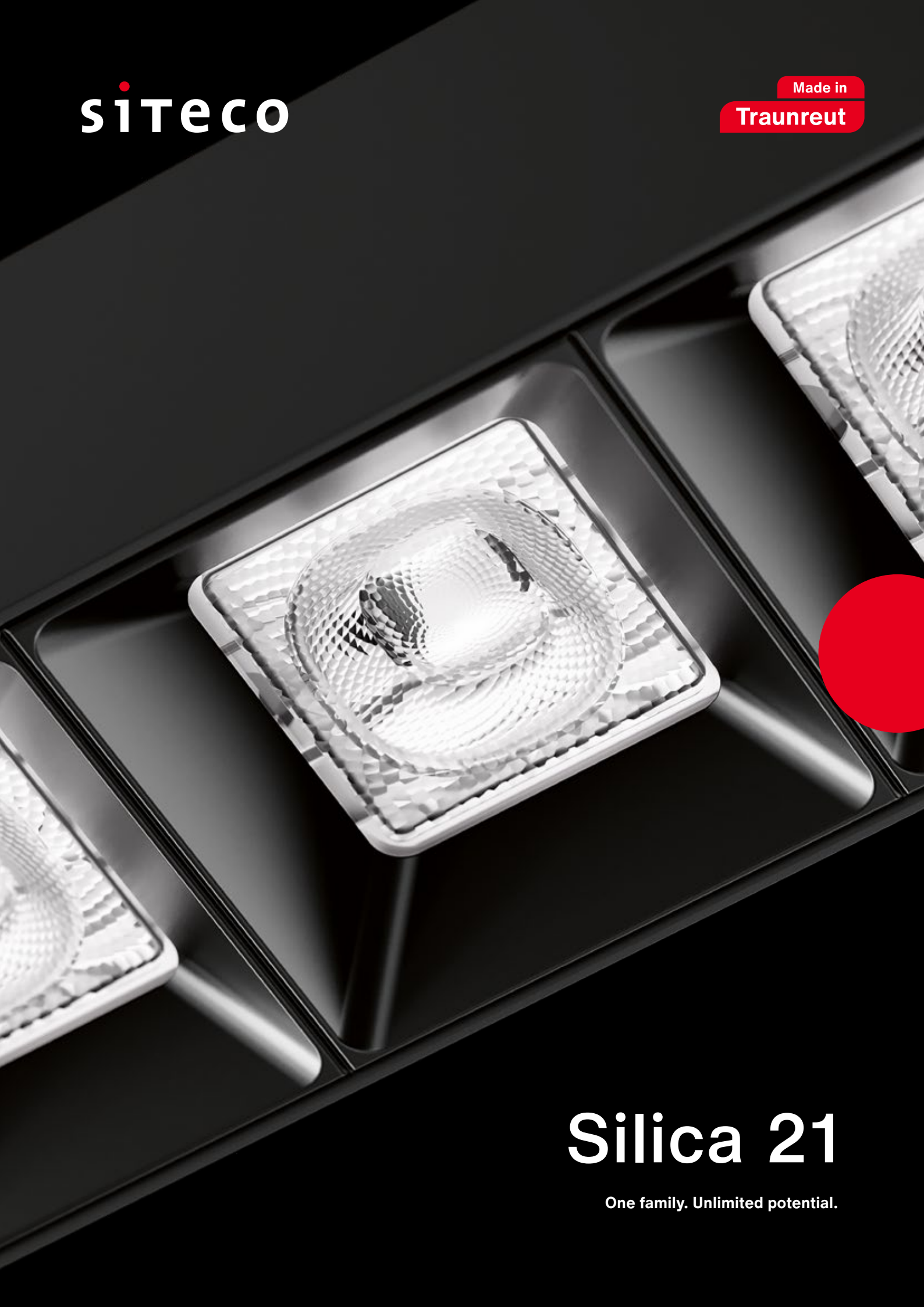

Silica 21

One family. Unlimited potential.

Silica 21

One family.

Unlimited potential.

Silica 21 is a versatile and customizable luminaire family with a consistent, elegant, and timelessly modern design language. Two optical technologies, four designs, and all standard mounting options offer you full design freedom.

Silica – A quantum leap in office lighting.



Optics.

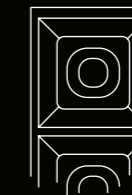

Shadow

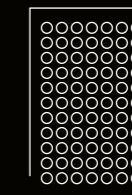

Prismatic

Design options.



Linear



Rectangular



Square



Round

Mounting options.



surface mount



recessed



pendant



floor

Light colors.



2,700 – 6,500 K*
Tunable White



3,000 K*



4,000 K*

Housing colors.



black



silver



white



upon request

Controls.



Presence sensor



DALI 2



Multilumen

*Available in CRI 80 / CRI 90

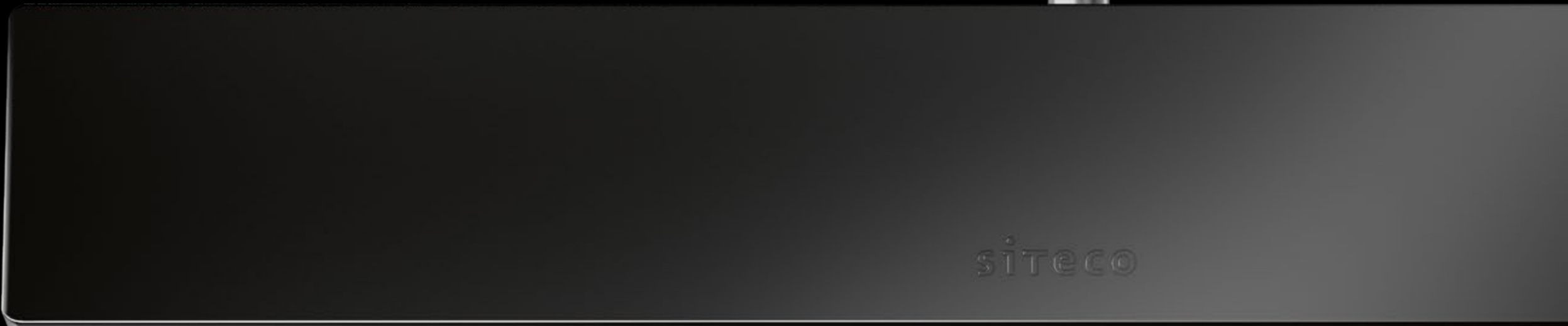

Silica Prismatic Rectangular



Silica Shadow Linear

Lighting technology. Two lenses – no compromises.

Shadow

A visible reflector and modular lens elements of the Shadow optic ensure targeted light distribution. For maximum flexibility from narrow to asymmetrical beams and precise light from every angle.

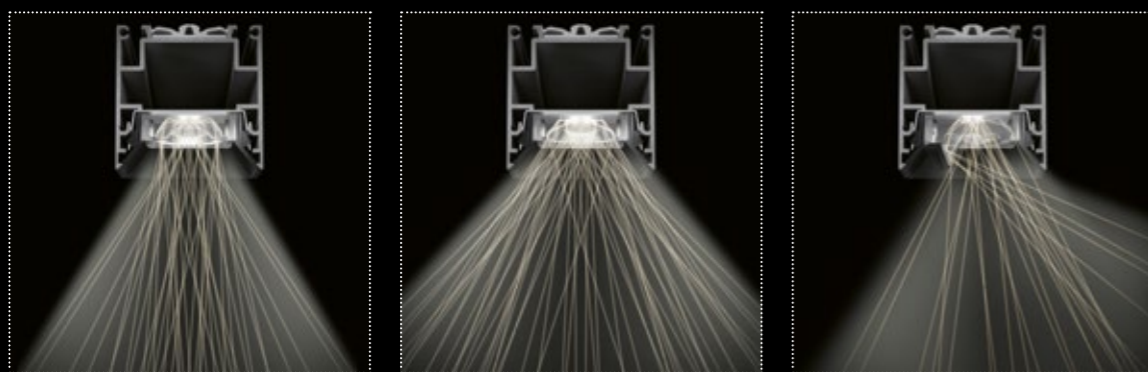

Narrow beam

Wide beam

Asymmetrical

Direct / indirect lighting options available.

Prismatic

The Prismatic optic with a microprismatic diffuser ensures harmonious light distribution, perfect glare control, and high flexibility with distributions from wide to extremely wide beams.

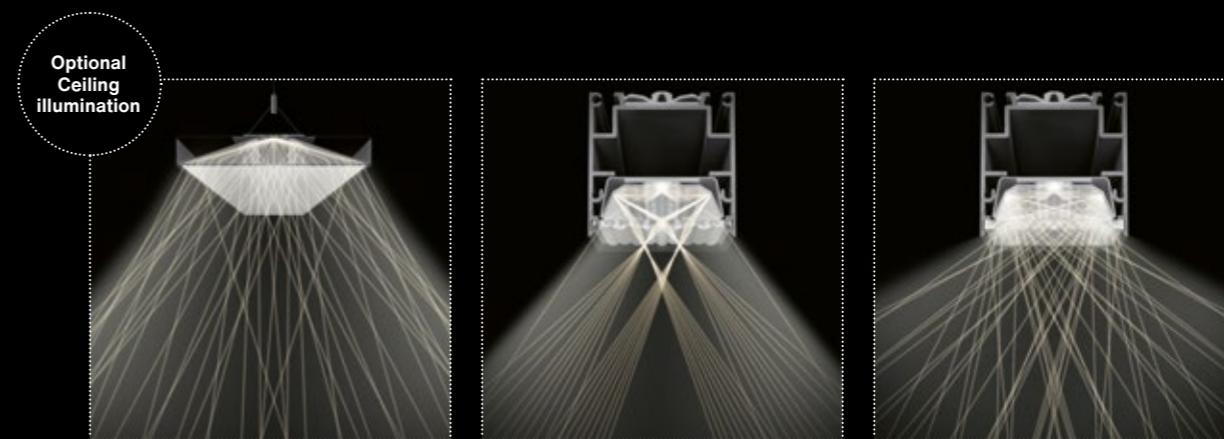
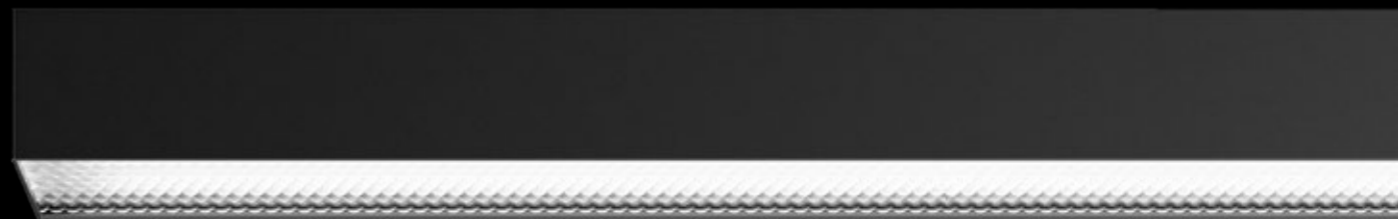

Wide beam
(Rectangular)

Wide beam

Extremely wide beam

Direct / indirect lighting options available.



Product: Silica 21 Prismatic Rectangular Floor

Shadow

Product portfolio.

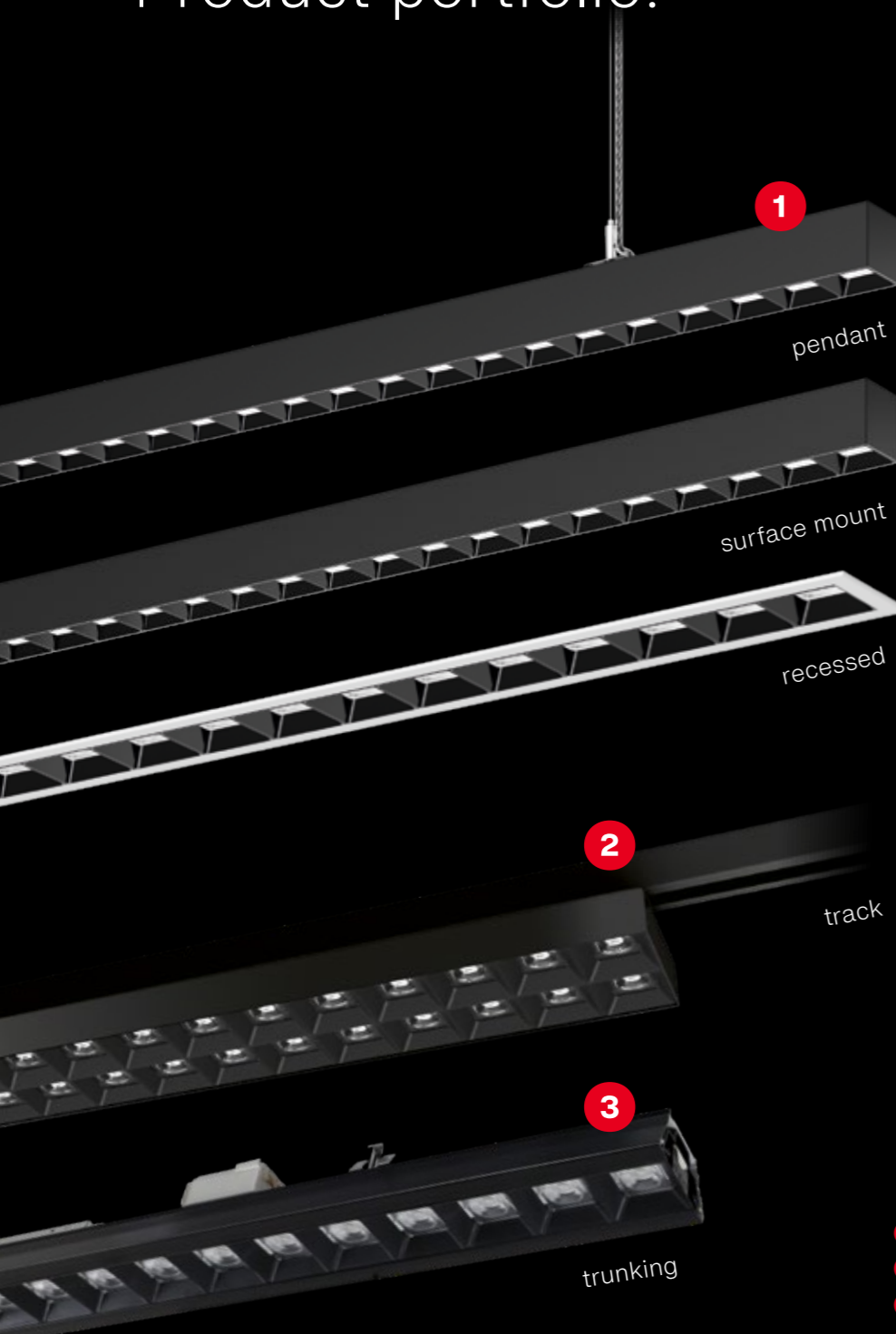

- 1 Silica Shadow Linear
- 2 Silica Shadow 3-Phase Track
- 3 Silica Shadow light insert for Licross
- 4 Silica Shadow Square
- 5 Silica Shadow Downlight
- 6 Silica Shadow Linear Floor

Housing colors:



Flexible

A wide range of mounting options and light distributions, a modular design concept, Tunable White, and UGR ≤ 19.

Efficient

Maximum energy efficiency of up to 185 lm/W – for reduced operating costs and a short payback period.

Sustainable

Replaceable components, simple upgrades, up to 100,000 hours of service life, DALI-2 control.



Product: Silica 21 Shadow Linear Recessed

Prismatic Product portfolio.

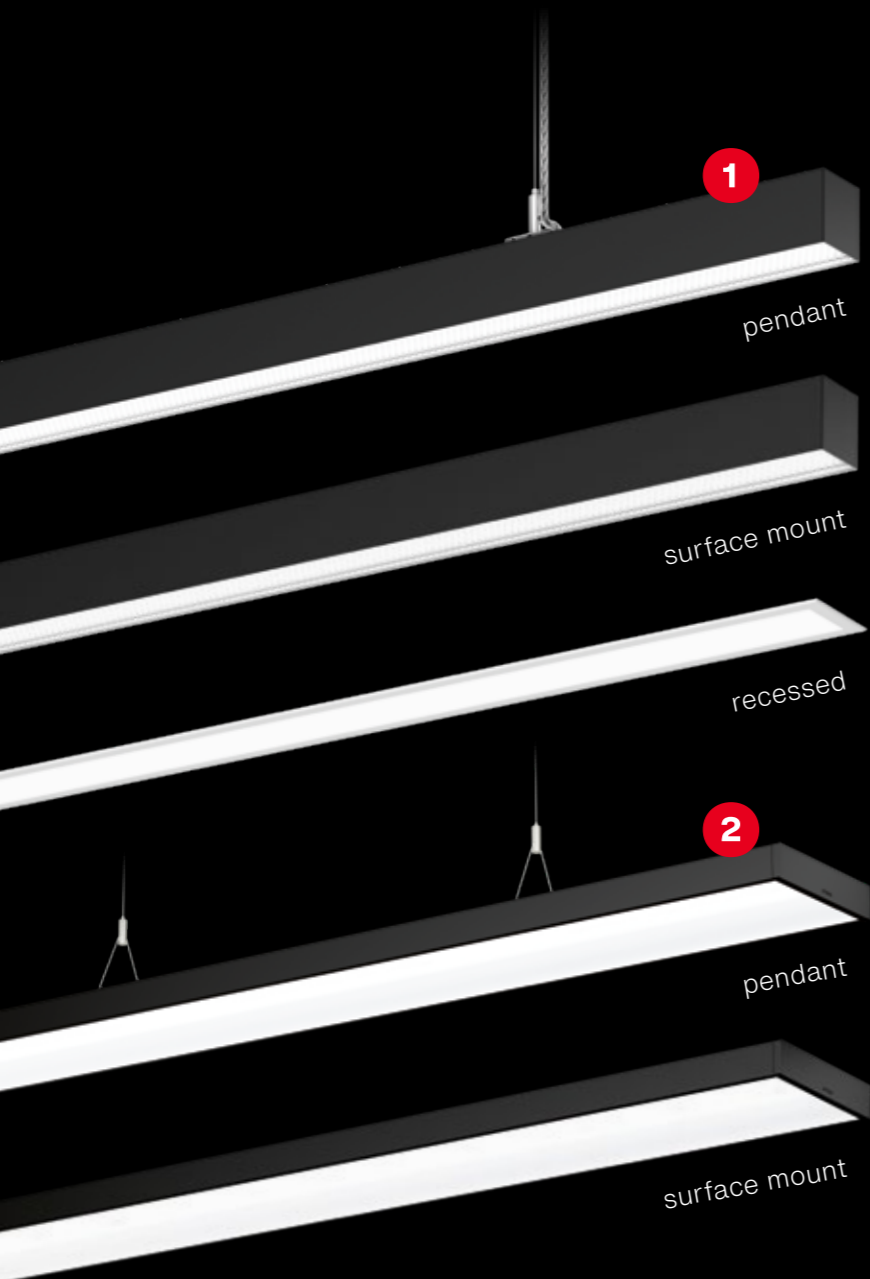

- 1 Silica Prismatic Linear
- 2 Prismatic Rectangular Silica
- 3 Silica Prismatic Linear Floor
- 4 Silica Prismatic Rectangular Floor

Housing colors:

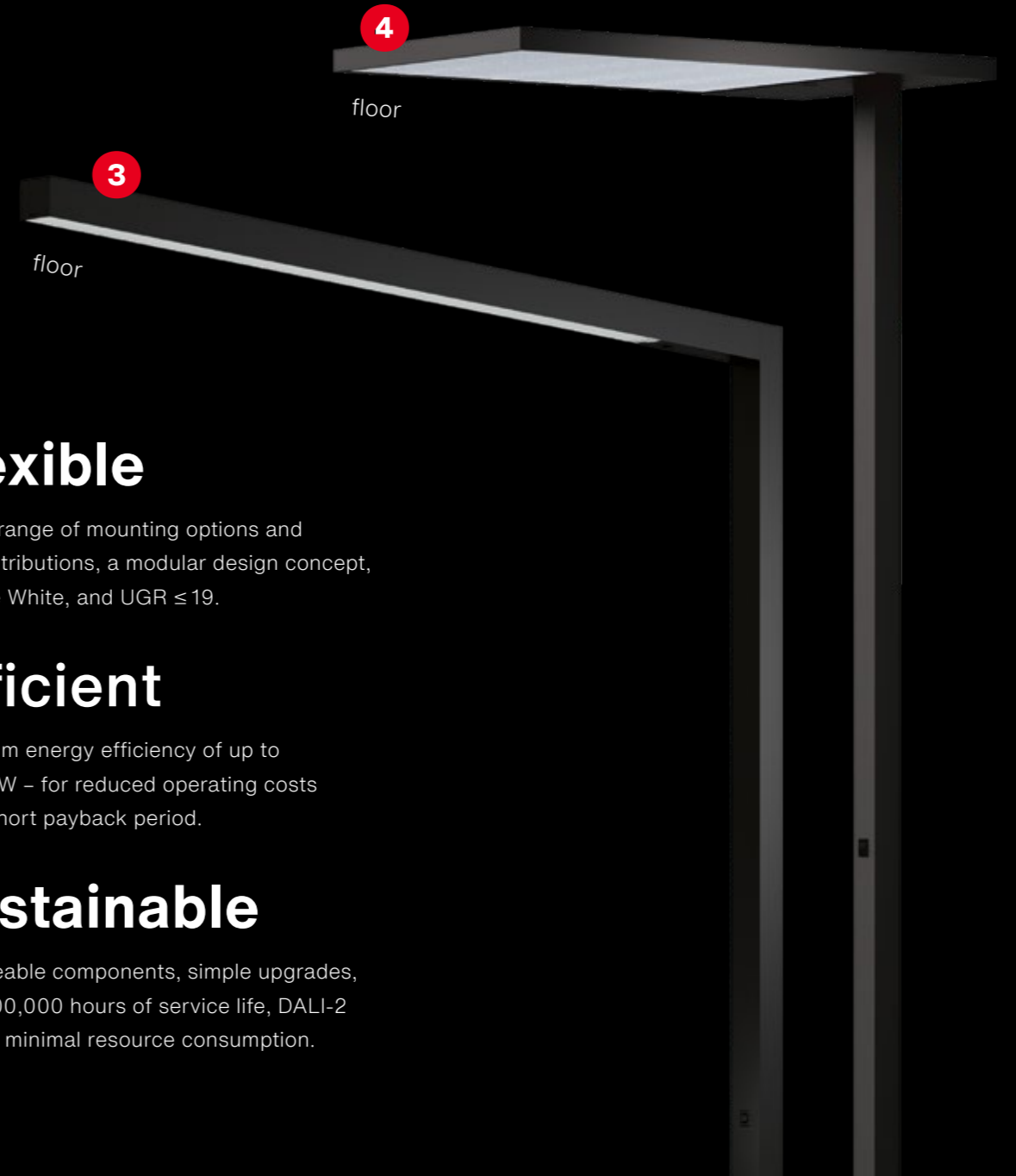
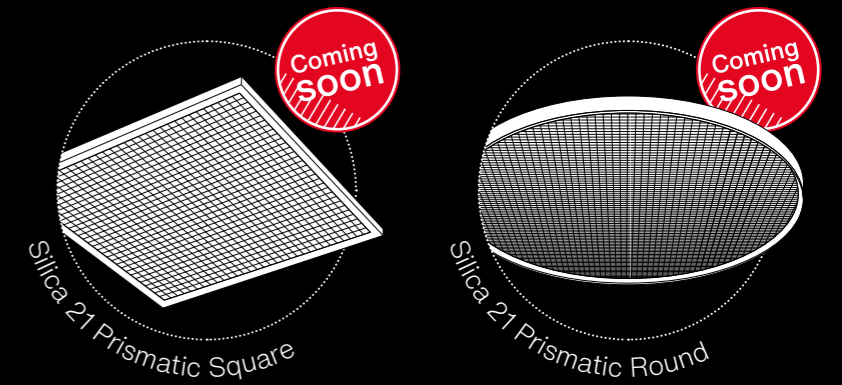

Flexible

A wide range of mounting options and light distributions, a modular design concept, Tunable White, and UGR ≤ 19 .

Efficient

Maximum energy efficiency of up to 180 lm/W – for reduced operating costs and a short payback period.

Sustainable

Replaceable components, simple upgrades, up to 100,000 hours of service life, DALI-2 control, minimal resource consumption.



Product: Silica 21 Prismatic Linear Surface Mount



Product: Silica 21 Prismatic Rectangular Pendant

Flexible and modular. Designed to fit every application.

Made in Traunreut, stands for modularity at its highest level. Our unique level of in-house development and manufacturing allows the customization of all luminaire components: electronics, optics, shape, and color.

Whether a new build, refurbishment, or custom solution – we push the boundaries of flexibility and sustainability for your project.

Quantum leap flexibility.



Made in
Traunreut

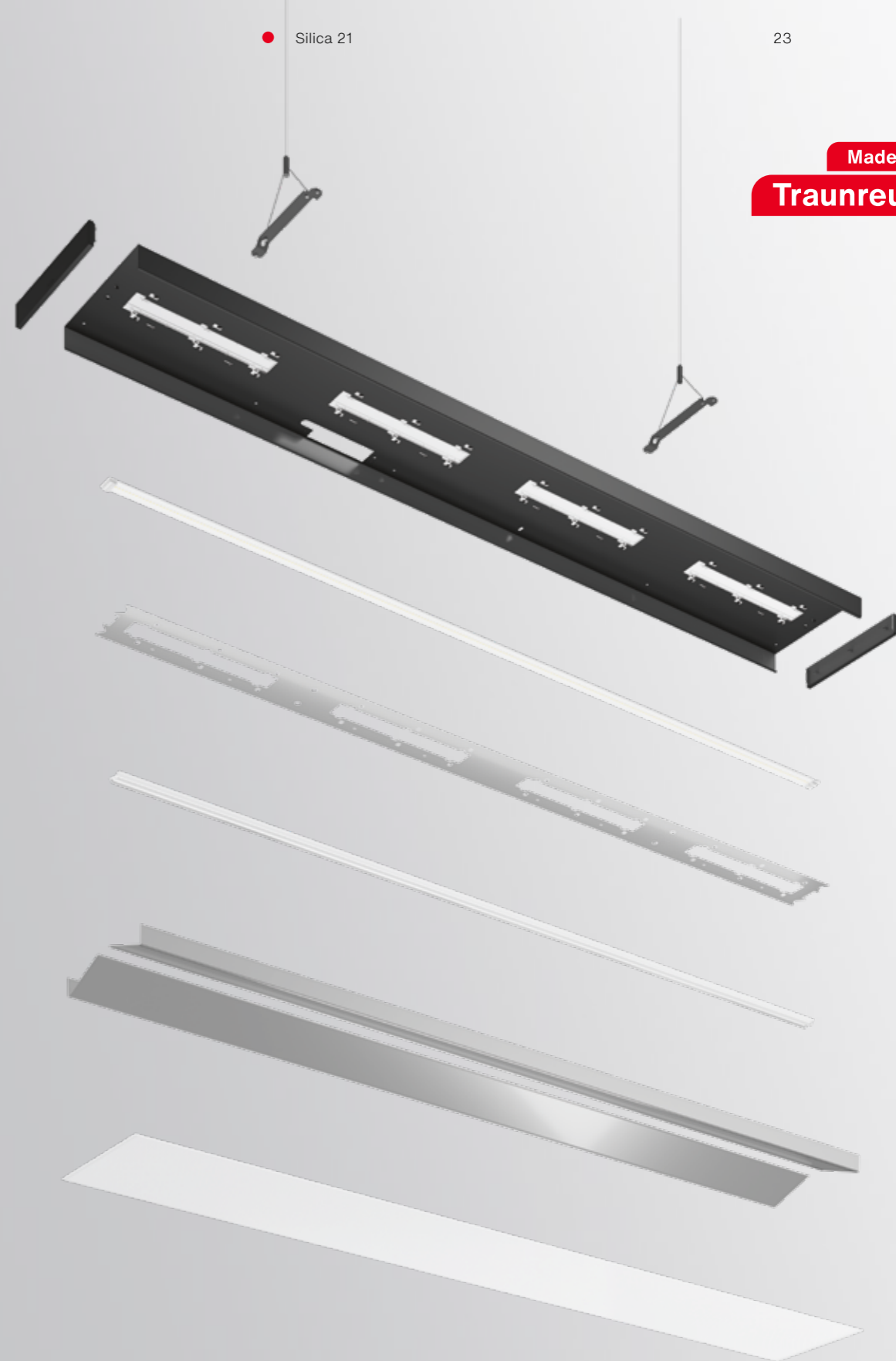

100 % customizable.

100 % sustainable.



Product: Silica 21 Shadow Linear Pendant

Efficient. Pays off immediately .

Up to 185 lm/W enable unmatched savings and minimal operating costs.

Even when upgrading first-generation LED luminaires to the latest LED technology, the switch pays off immediately.

Quantum leap efficiency.

Up to
80%
less CO₂ and energy costs

Approx.
2 year
payback period



Intelligent sensor technology for maximum savings.

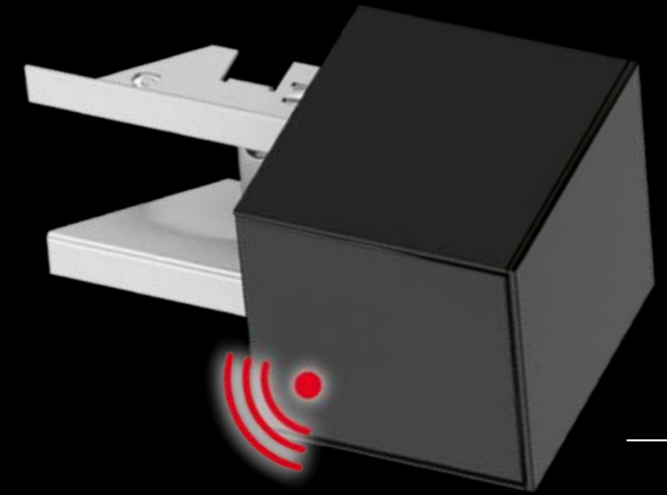
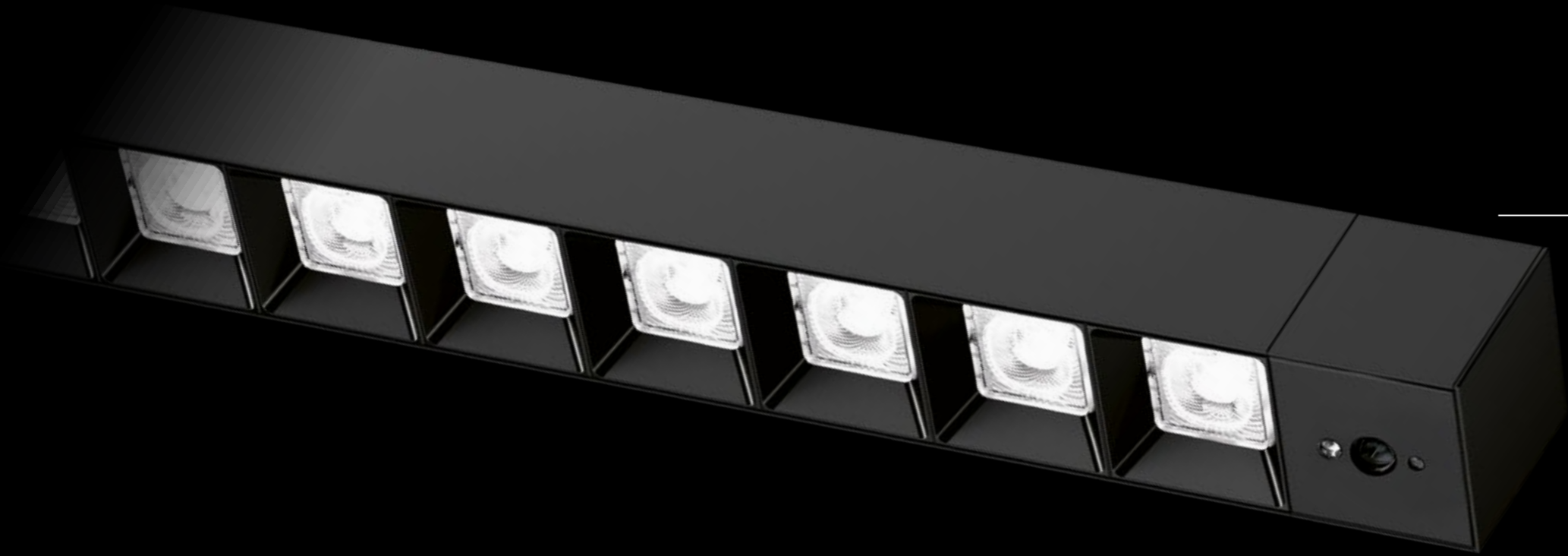

- Highly efficient.**
 Presence and daylight control for maximum energy and CO₂ savings.
- Maximum flexibility.**
 Fully scalable and tailored to your needs.
- Future-proof.**
 Flexible adaptation to changes in use (e.g. modified room layouts or furnishings).
- Full freedom of design.**
 With open standards, wireless or wired control for refurbishments and new buildings, and seamless integration with modern lighting and building management systems, GEG and EPBD requirements can be met.
- Casambi-ready:**
 The luminaires are Casambi-ready and are available either as a Casambi version or as sensor version with integrated light and presence sensors.

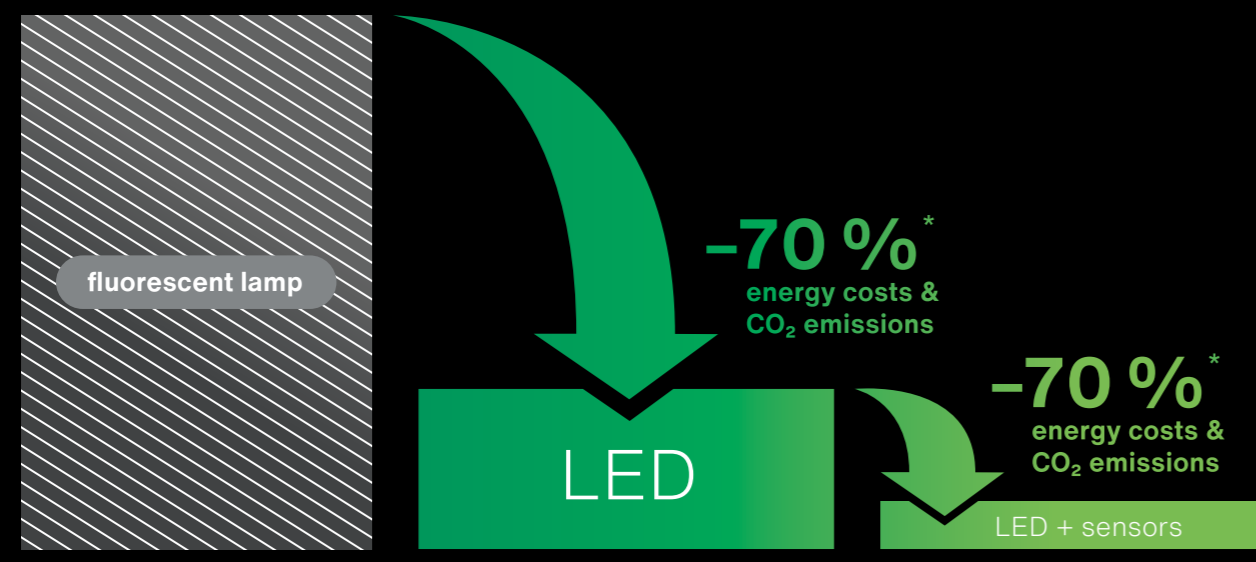

*Savings depend on application and user behavior.



Made in
Traunreut

Sustainable. Consistently implemented in Traunreut.

Sustainability is a standard we live by.

Made in Traunreut stands for short supply chains, measurably lower resource consumption, and clear responsibility.

From development to electronics manufacturing, everything takes place on site at our facility near Lake Chiemsee in Bavaria – developed and manufactured with a clear commitment to sustainability. This also allows us to operate independently and respond quickly to customer needs.

Quantum leap sustainability.

100 % In-house development
and local manufacturing

100 % Customizability
and replaceability



> 60,000 m²
production area

2 days
production time for
custom LED modules.

> 1,000
employees

CLO 2.0, Human Centric Lighting, a globally unique silver coating.
We stand for more than 200 patented lighting technologies –
developed and implemented in Traunreut.

**Innovation.
Sustainability.**

Made in
Traunreut

Holistic luminaire development and manufacturing from Traunreut:
optics, mechanics, thermal design, and control electronics perfectly integrated.
Our in-house electronics manufacturing enables us to implement individual
customer requirements quickly and with outstanding quality.



Silica 21 at a glance. Shadow.

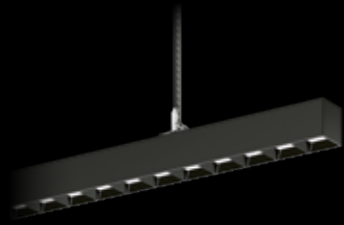

Silica 21 Shadow
Linear Pendant

Technical specifications

Luminous flux: up to 21,890lm
Power: up to 138W
Luminous efficacy: up to 181lm/W
Service life: 70,000 hours (L80)
Light distribution: narrow beam,
wide beam, wall washer

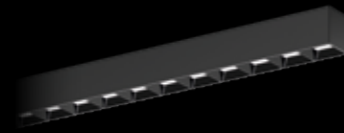

Silica 21 Shadow
Linear Surface Mount

Technical specifications

Luminous flux: up to 12,960lm
Power: up to 93.4W
Luminous efficacy: up to 185lm/W
Service life: 70,000 hours (L80)
Light distribution: narrow beam,
wide beam, wall washer



Silica 21 Shadow
Linear Recessed

Technical specifications

Luminous flux: up to 12,960lm
Power: up to 87.8W
Luminous efficacy: up to 185lm/W
Service life: 70,000 hours (L80)
Light distribution: narrow beam,
wide beam, wall washer

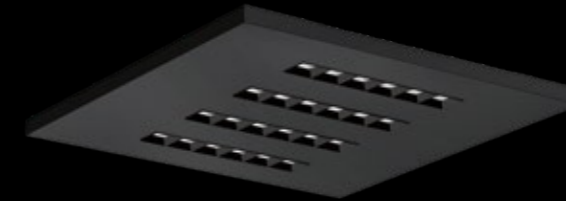

Silica 21 Shadow
Square Recessed

Technical specifications

Luminous flux: up to 4,600lm
Power: up to 32.8W
Luminous efficacy: up to 170 lm/W
Service life: 70,000 hours (L85)
Light distribution: wide beam

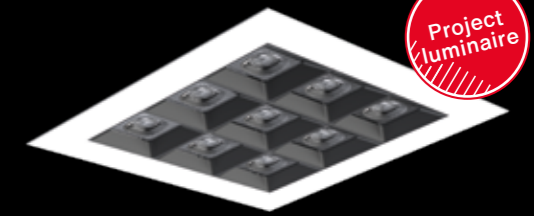

Silica 21 Shadow
Linear Downlight

Technical specifications

Available upon request

Applies to all Linear and Square variants:

Optical concept: Darklight reflector made of PMMA

Light colors: Tunable White | 3,000 K | 4,000 K

UGR: ≤ 19

Color rendering index: CRI ≥ 80

Driver: DALI 2 | DALI DT8

Mounting: suspended | recessed | surface-mounted | continuous row configuration available

Areas of application: Individual and open-plan offices, conference and meeting rooms, reception areas and foyers, corridors and circulation areas, home offices, creative spaces, lounges, technical workstations

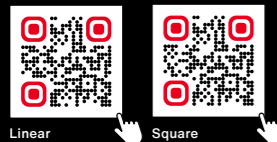

Types,
data sheets,
configuration -
everything at
a glance.

Silica 21 at a glance. Shadow.



Silica 21 Shadow
for Licross

Technical specifications

Luminous flux: up to 6,340 lm

Power: up to 39 W

Luminous efficacy: up to 178 lm/W

Service life: 75,000 hours (L80)

Light distribution: wide beam

Applies to all Licross variants:

Optical concept: Darklight reflector made of PMMA

Light colors: 4,000 K, 5,000 K, 6,000 K, 7,000 K

UGR: ≤ 19

Color rendering index: CRI ≥ 80

Driver: DALI 2

Mounting: Plug-in installation in the Licross® mounting rail

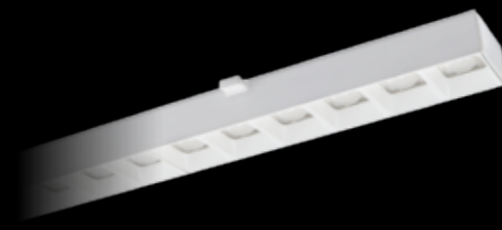

Silica 21 Shadow
for Modario

Technical specifications

Luminous flux: up to 6,710 lm

Power: 38 W

Luminous efficacy: up to 177 lm/W

Service life: 70,000 hours (L80)

Light distribution: medium, double asymmetrical

Valid to all Modario 31 variants:

Optical concept: Darklight reflector made of PMMA

Light colors: 4,000 K, 5,000 K, 6,000 K, 7,000 K

UGR: ≤ 19 | ≤ 22

Color rendering index: CRI ≥ 80

Driver: DALI 2 | ON/OFF Multilumen

Mounting: Plug-in installation in the Modario® 31 mounting rail



Silica 21 Shadow Linear Floor
Floor luminaire

Technical specifications

Luminous flux: up to 14,320 lm

Power: 106 W

Luminous efficacy: up to 167 lm/W

Service life: 50,000 hours (L85)

Light distribution: direct / indirect beam

Applies to all floor luminaire variants:

Optical concept: PMMA | Prismatic lens

Light colors: 3,000 K | 4,000 K | 5,000 K

UGR: ≤ 19

Color rendering index: CRI ≥ 80

Driver: DALI 2



Types,
data sheets,
configuration -
everything at a glance.

Silica 21 at a glance. Prismatic.



Silica 21 Prismatic
Rectangular Pendant

Technical specifications

Luminous flux: up to 8,050lm
Power: up to 51W
Luminous efficacy: up to 180 lm/W
Service life: up to 100,000 hours (L85) at Tmax
Light distribution: wide beam

Applies to all Rectangular variants:

Optical concept: Microprismatic optics
Light colors: Tunable White | 3,000 K | 4,000 K | CRI > 80, > 90
UGR: < 19
Driver: DALI 2 | DALI DT8
Mounting: Pendant kit, single or continuous row configuration, through-wiring
Areas of application: Individual and open-plan offices, conference and meeting rooms, reception areas and foyers, corridors and circulation areas, home offices, creative spaces, lounges, technical workstations



Silica 21 Prismatic
Rectangular Surface Mount

Technical specifications

Luminous flux: up to 5,500lm
Power: up to 36.6W
Luminous efficacy: up to 175 lm/W
Service life: up to 100,000 hours (L85) at Tmax
Light distribution: wide beam, wall washer



Silica 21 Prismatic
Linear Pendant

Technical specifications

Luminous flux: up to 20,060lm
Power: up to 138W
Luminous efficacy: up to 174lm/W
Service life: 70,000 hours (L80)
Light distribution: narrow beam, extremely wide beam



Silica 21 Prismatic
Linear Surface Mount

Technical specifications

Luminous flux: up to 9,840lm
Power: up to 62.2W
Luminous efficacy: up to 158lm/W
Service life: 70,000 hours (L80)
Light distribution: extremely wide beam



Silica 21 Prismatic
Linear Recessed

Technical specifications

Luminous flux: up to 9,840lm
Power: up to 85W
Luminous efficacy: up to 158lm/W
Service life: 70,000 hours (L80)
Light distribution: extremely wide beam

Applies to all Linear variants:

Optical concept: Prismatic optics
Light colors: Tunable White | 3,000 K | 4,000 K
UGR: ≤ 19 | ≤ 22
Color rendering index: CRI ≥ 80
Driver: DALI 2 | DALI DT8
Mounting: suspended, recessed, surface-mounted, continuous row configuration available
Areas of application: Individual and open-plan offices, conference and meeting rooms, reception areas and foyers, corridors and circulation areas, home offices, creative spaces, lounges, technical workstations



Silica 21 Prismatic Rectangular Floor luminaire

Technical specifications

Luminous flux: 13,280lm
Power: up to 90W
Luminous efficacy: up to 157lm/W
Service life: 50,000 hours (L85)
Light distribution: direct / indirect beam



Silica Prismatic Linear Floor luminaire

Technical specifications

Luminous flux: up to 15,000lm
Power: up to 106W
Luminous efficacy: up to 141lm/W
Service life: 50,000 hours (L85)
Light distribution: direct / indirect beam

Applies to all floor luminaire variants:

Optical concept: PMMA, prism lens
Light colors: 3,000 K | 4,000 K | 5,000 K
UGR: ≤ 19
Color rendering index: CRI ≥ 80
Driver: DALI 2



Linear



Rectangular



Floor luminaire

Types, data sheets, configuration - everything at a glance.

Quantum leap lighting solution.

Made in
Traunreut

SITECO develops lighting solutions that set standards.

Our unique combination of expertise in lighting, control, project
and operation creates solutions that are more than just light:
they are your competitive edge. For over 160 years.

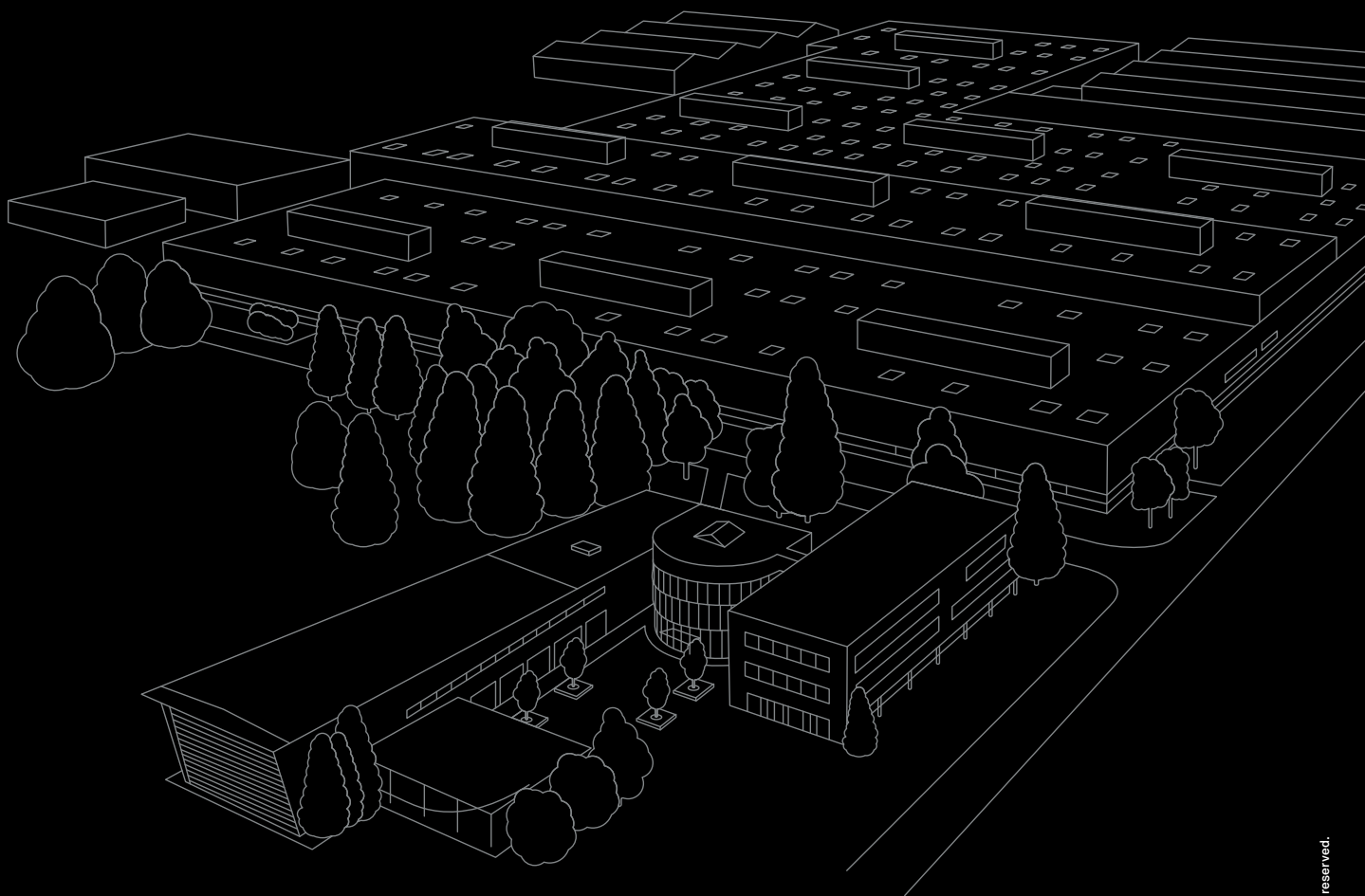

Contact.

Siteco GmbH

Georg-Simon-Ohm-Str. 50
83301 Traunreut, Germany
Tel. +49 8669 330
sales-int@siteco.com

[siteco.com](https://www.siteco.com)