

siteco

Made in
Traunreut

Trunking systems

The best system. For every application.

More ...
efficient.
flexible.
robust.

Licross 11 / 21

The digital infrastructure of the future.

- 14 cores max.
- Efficiency 209 lm/W
- Service life up to 100,000 h
- Failsafe, patented contact block and robust quick-release catches
- 14 beam characteristics
- 6 light colors incl. Tunable White
- Color rendering max. CRI 90
- Protection rating max. IP64
- Ambient temperature max. +50 °C
- 650 V DC for PV-based power supply

209
lm/W

14
cores

More
robust

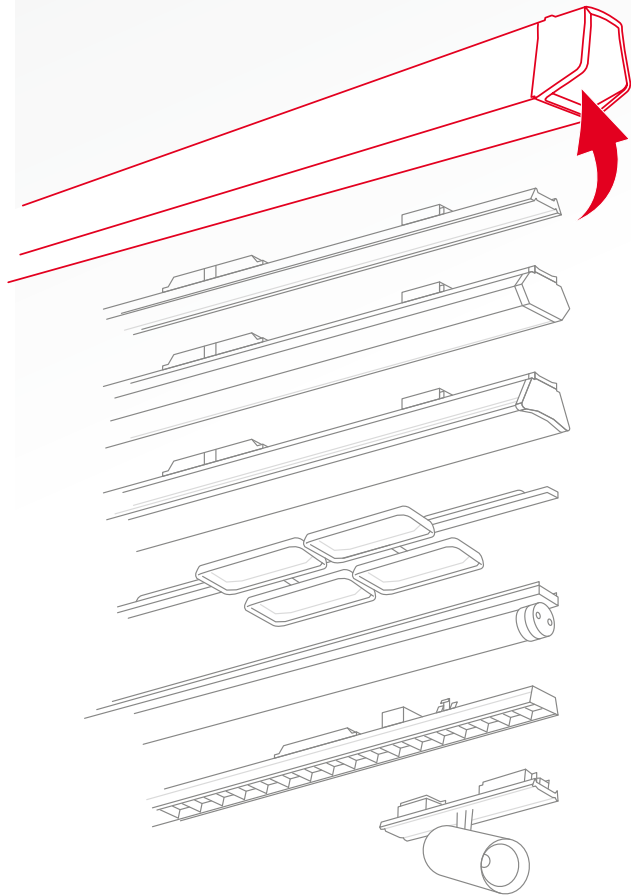

Modario 31

The classic, now with up to 12 cores.

- 12 cores max.
- Efficiency > 180 lm/W
- Service life up to 70,000 h
- 4 beam characteristics
- 2 light colors
- Color rendering CRI 80
- Protection rating max. IP50
- Ambient temperature max. +40 °C

> 180
lm/W

12
cores

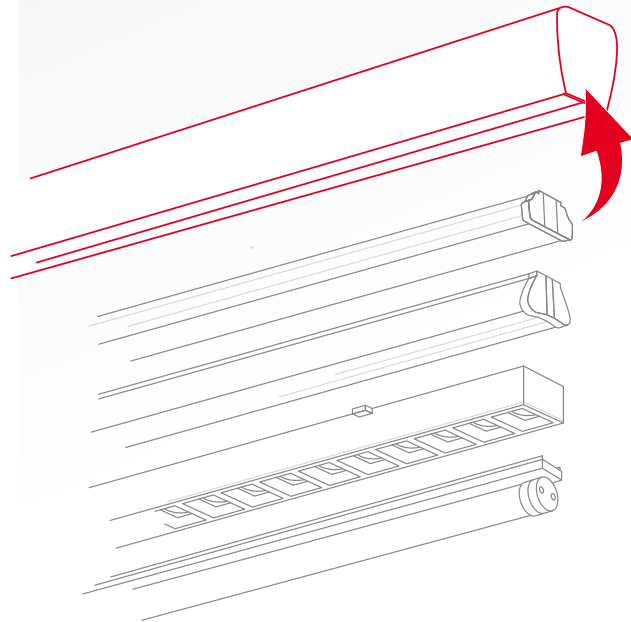

The best system.

DUS 31

> 180
lm/W

The refurbishment solution for the trunking pioneer.

- Efficiency > 180 lm/W
- Service life up to 70,000 h
- 2 beam characteristics
- 2 light colors
- Color rendering CRI 80
- Protection rating max. IP50
- Ambient temperature max. +40 °C

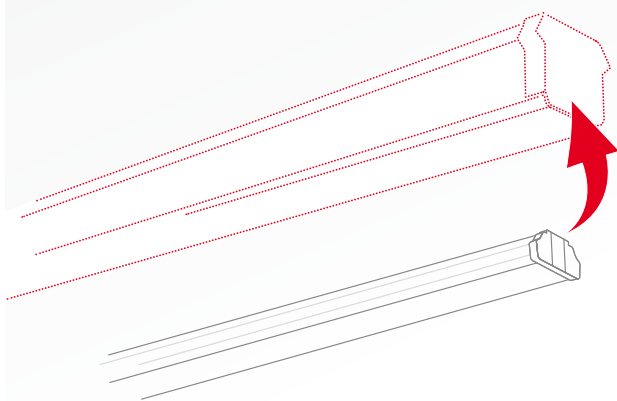

Trunking Flex 31

> 160
lm/W

The refurbishment solution for all trunking systems.

- Efficiency > 160 lm/W
- Service life > 50,000 h
- 5 beam characteristics
- 4 light colors
- Color rendering CRI 80
- Ambient temperature max. +40 °C

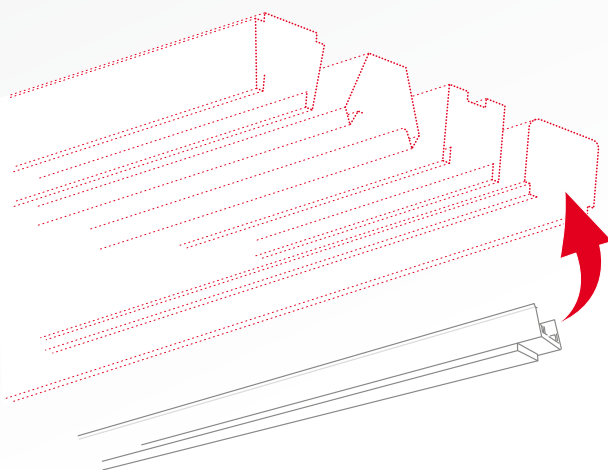

SITECO has been a trunking pioneer for 50 years.

And because we never stop improving, you find the best solution here for every application.

For every application.

Licross

209
lm/W

14
cores

More
robust

The digital infrastructure of the future.



Quantum leap in efficiency.

With 209 lm/W, Licross is the most efficient trunking system on the market, thus ensuring minimum operating costs and extremely fast amortization.

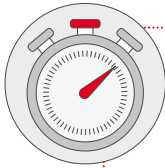

The assembly world champion.

Installation in record time. Tool-free installation of all electrical and mechanical components. New contact block and catches for a new level of speed and reliability in assembly.

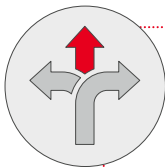

One system for all applications.

Add damp-proof luminaires, highbay luminaires, emergency lighting and office luminaires with one-click installation. Integrate loudspeakers and cameras, transmit data, and incorporate WiFi hotspots or even indoor positioning systems.



Integrated emergency lighting.

Two emergency power supplies possible thanks to 14 cores. Emergency luminaire inserts for central and single battery support all standard emergency lighting systems.



Industry 4.0.

The world's first trunking system with 14 cores enables data transmission at up to 1 Gbit/s, making it your data highway for Industry 4.0.

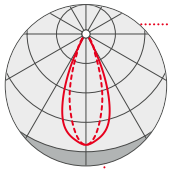
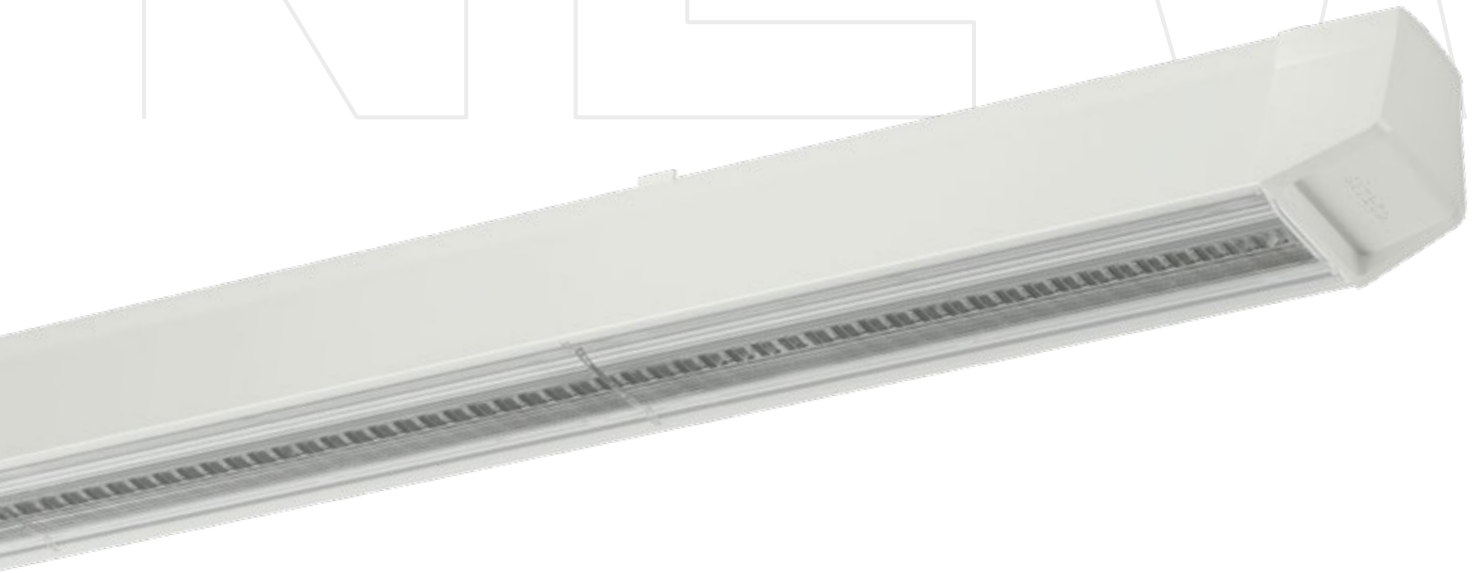
**Fully optimized light distributions.**

You will always find the right light for every application with Licross. Optimized optical systems ensure efficient illumination, optimum visual comfort with the best color rendering and excellent glare control.

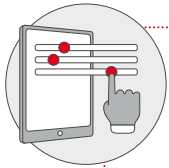
**Full control.**

Optimized sensors save energy everywhere. Control the light according to daylight and presence. The Matrix sensor prevents incorrect switching by driverless transport systems, since it distinguishes between people and machines.

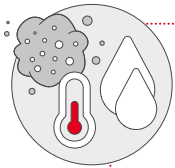
**Extremely robust.**

Dust, moisture and high temperatures? No problem. High protection ratings up to IP64 and temperature resistance up to 50 °C enable use even in harsh environments.

Why efficiency counts.

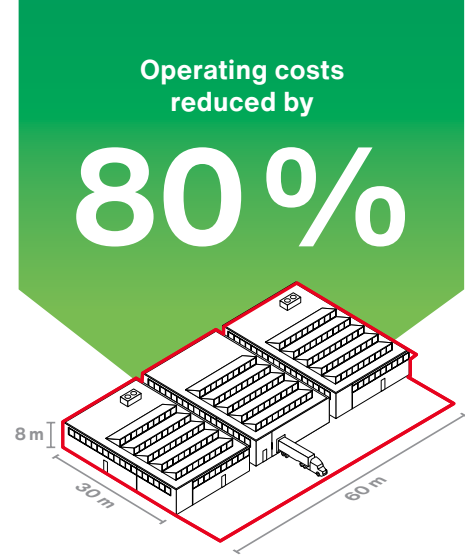

Because it pays off.

Calculation example for a new lighting system with 209 lm/W.

	old installation	new installation	
Luminaire type	4 × 58W, ECG	Licross Recessed	
Number of luminaires	153	162	
Energy consumption per year in kWh	138,753	28,979	-80%
Reduction in energy consumption per year in kWh		-109,774	
CO₂ emissions per year in t	59.2	12	-80%
Reduction in CO₂ emissions per year in t		-47.2	
Operating costs per year in €	42,624	8,463	-80%
Savings per year in €		-34,161	

Calculation based on energy price of 0.26 €/kWh.

With 209 lm/W, even faster amortization and significantly lower energy costs over the service life. With the new Licross, you save an additional 41,000 euros in energy costs over the service life compared to the standard.



Assembly world champion.

More robust for maximum assembly speed.

The patented Licross contact block has been further optimized: **installation now even faster and, above all, safer.**

Safe positioning of inserts thanks to large guiding rib.

Exact alignment of the contacts and cores.

Robust spring construction ensures a secure grip.

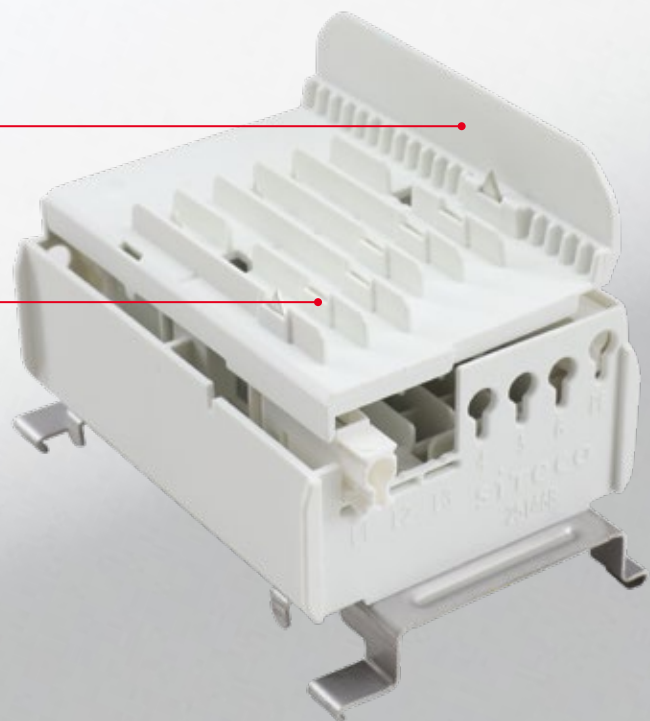

The new quick-release catch guarantees lightning-fast insertion and secure mounting of the inserts in the trunking rail. The catch hook prevents anything from accidentally falling off.

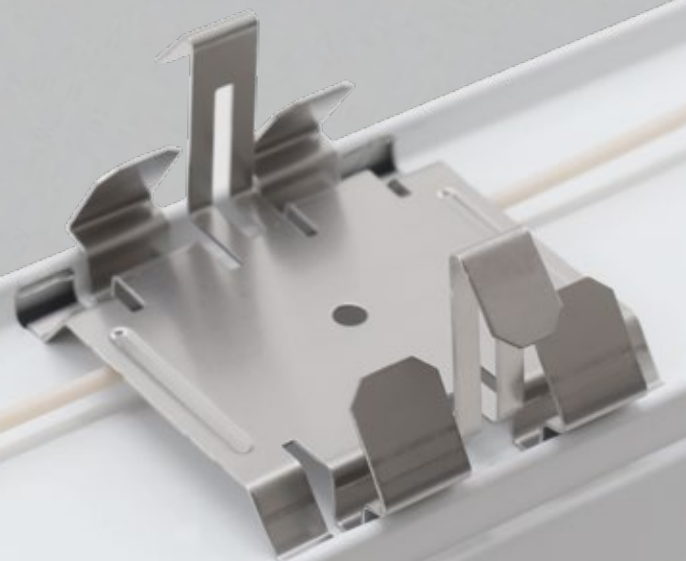



Licross

Setting the course for tomorrow today.

State-of-the-art lighting technology means maximum efficiency. That's not enough for us. We offer a system that becomes the backbone of your building infrastructure and goes far beyond lighting. A solution with maximum flexibility in application that is already equipped for the requirements of the future.

Licross - the backbone of your digital infrastructure.

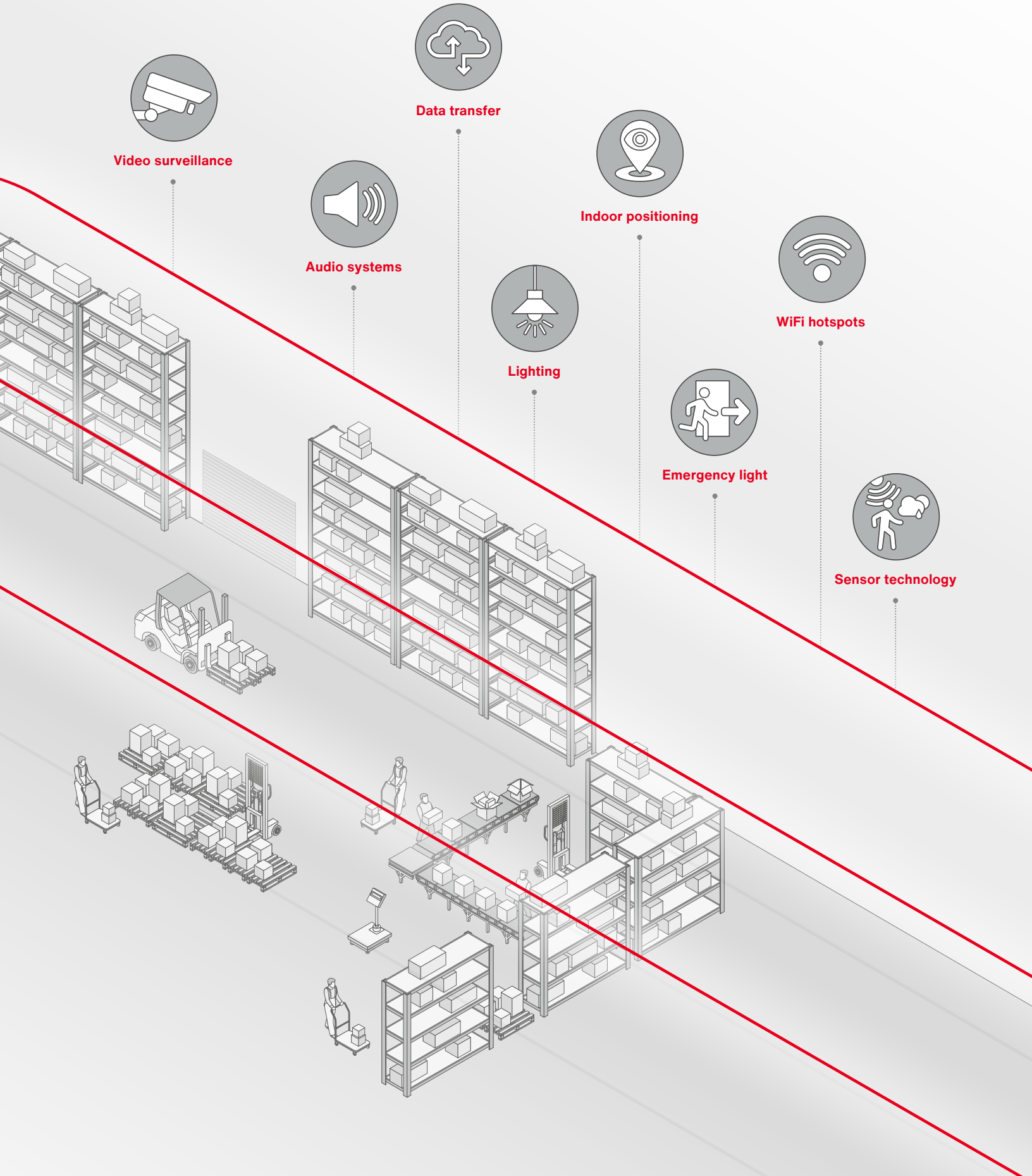

Maximum flexibility. Expandable and freely configurable.

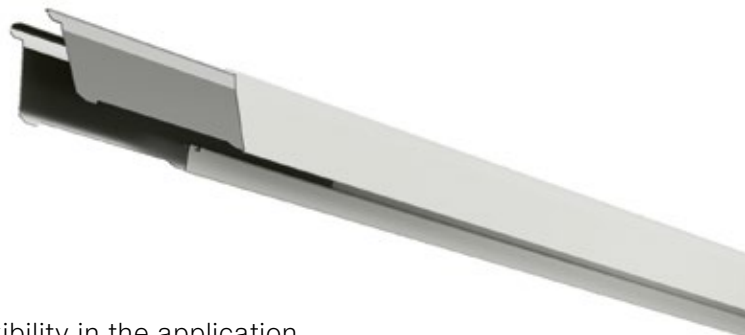

The backbone of your building infrastructure.

Licross trunking system – the rail

- Future-proof thanks to 14 cores and with maximum flexibility in the application
- Linear through-wiring with fully variable tapping option for the inserts
- Available from 5-core to 14-core (2.5 mm²)
- Lengths: 4.5 m, 3 m and 1.5 m
- Tool-free mechanical and electrical connection of rails and inserts
- Protection ratings: from IP20 to IP64 with one rail
- Integration of various emergency lighting components in accordance with EN 60598-2-22



Discover
now

Did you know?

Licross inserts can be mounted **anywhere** in the rail. Tedious calculations in system dimensions are a thing of the past. **Made possible by the patented tap.**

Flexible arrangement of the luminaire inserts:

Seamless arrangement of the luminaire inserts



Flexible arrangement of the luminaire inserts



Grid spacing of the luminaire inserts



14 cores. When more is simply more.

Licross is available with up to 14 cores. Without additional wiring effort. That makes it easy to integrate more functions into the rail, e.g. three phases for light, two DALI-lines and two emergency supplies plus audio transmission.

Wide range of applications thanks to 14 cores.

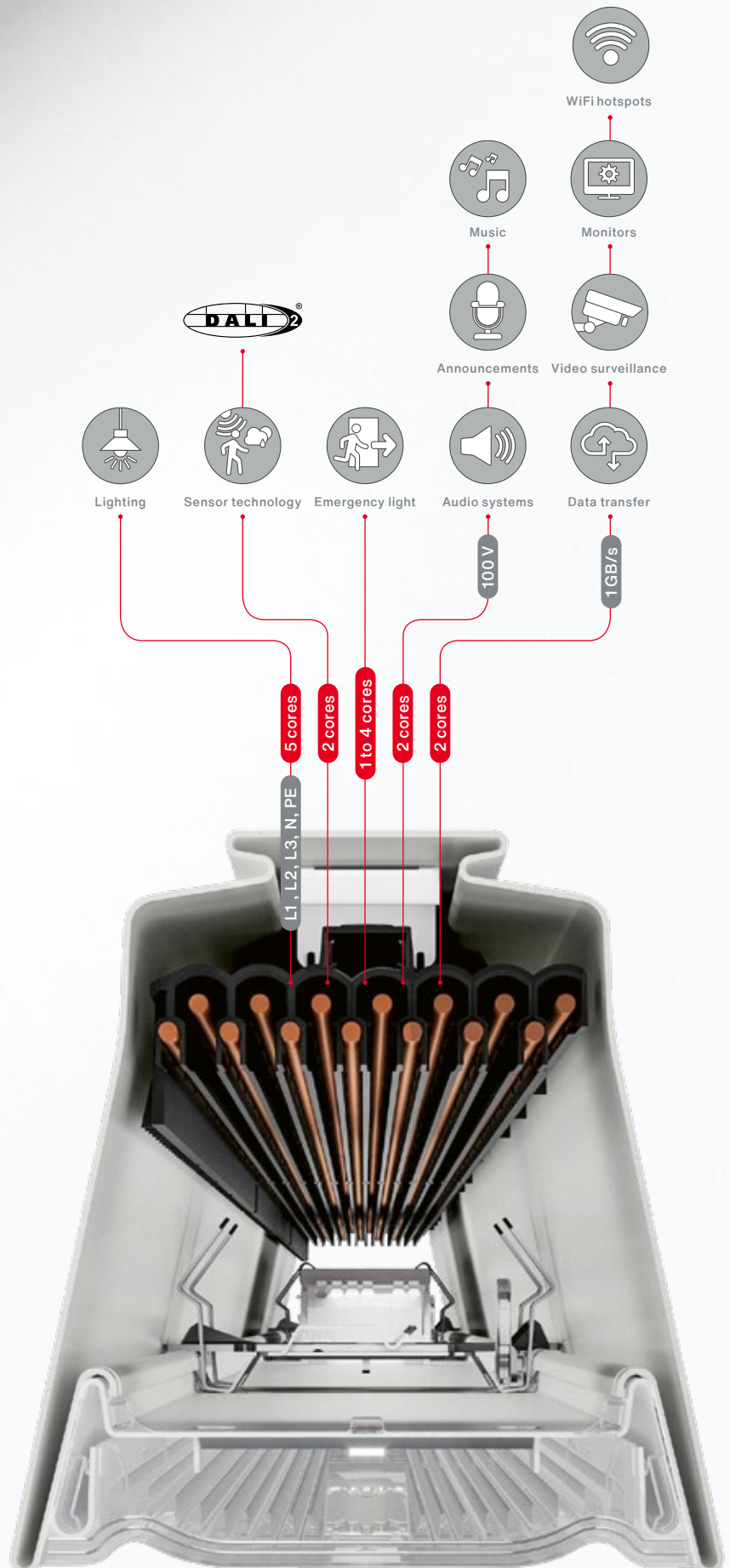

Licross 11 / 21

Maximum flexibility.

Whether for industry, retail or the office, you will always find the right solution thanks to lumen packages, optics, protection ratings and temperature ranges optimized to suit the respective application.

Licross

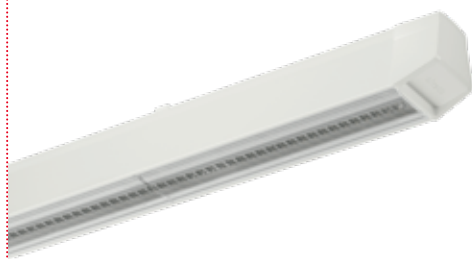

Recessed
The flexible all-rounder



Opal
Uniform light for ancillary areas

Application	11 21	General lighting in halls, retail spaces, schools, ...	Preferred for low rooms, ancillary spaces and garages; for a pleasant lighting atmosphere thanks to 12 % indirect light component
Distribution	11 21	narrow / medium / wide / diffuse / elliptical narrow / asymmetrical / double asymmetrical	opal / diffuse direct beam with 12 % indirect light component
Light colors	11	2700 ... 6500 / 3000 / 3500 / 4000 / 5000 / 6500	3000 / 3500 / 4000 / 5000 / 6500
K	21	3000 / 3500 / 4000 / 5000 / 6500	3000 / 3500 / 4000 / 5000 / 6500
Glare control	11	$\leq 19 / \leq 22 / \leq 25 / \leq 28$	$\leq 22 / \leq 25 / \leq 28$
UGR	21		
Luminous flux	11	4,300 to 27,200	2,750 to 26,350
lm	21	4,000 to 22,700	2,750 to 22,050
Luminous efficacy	11	> 200 lm/W	> 185 lm/W
max. lm/W	21	> 190 lm/W	> 175 lm/W
Type of protection	11	IP40 / IP54	IP40 / IP54
Ambient temp.	11	+50 °C	+ 45 °C
max.	21		
Service life	11	100,000 h	100,000 h
	21	75,000 h	75,000 h

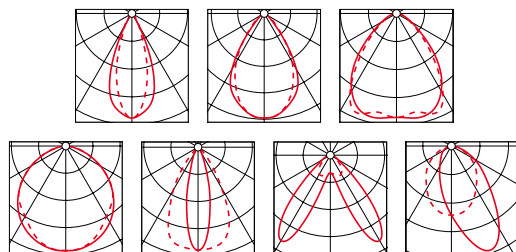

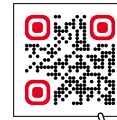

Discover Licross 11 now



Discover Licross 21 now



Protected
The professional for the industry

Performance
A plus in light

General lighting in rooms with high humidity or dust ...

Workplace lighting with high visual requirements ...

extr. narrow/narrow/narrow with ceiling illumination / wide with ceiling illumination

direct / indirect wide

2700 ... 6500 / 3000 / 4000 / 5000 / 6500

2700 ... 6500 / 4000 / 5000 / 6500

4000 / 5000

4000 / 5000

≤ 19 / ≤ 22 / ≤ 25 / ≤ 28

≤ 19 / ≤ 22 / ≤ 25

5,500 to 16,100

5,000 to 15,050

> 170 lm/W

> 185 lm/W

IP54 / IP64

IP40 / IP54

+50 °C

+50 °C

100,000 h

100,000 h

75,000 h

75,000 h

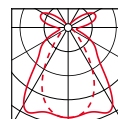
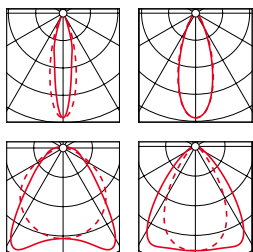

Full flexibility.

Expandable and freely configurable. Virtually unlimited possibilities thanks to the optional integration of a wide range of SITECO inserts.



Emergency lighting as a system component: Licross 21 emergency lighting

- Ideal for illuminating spaces as well as escape and rescue routes at mounting heights of 2.5 to 17 m
- All essential emergency lighting systems can be integrated using a multifunctional insert or other specific inserts

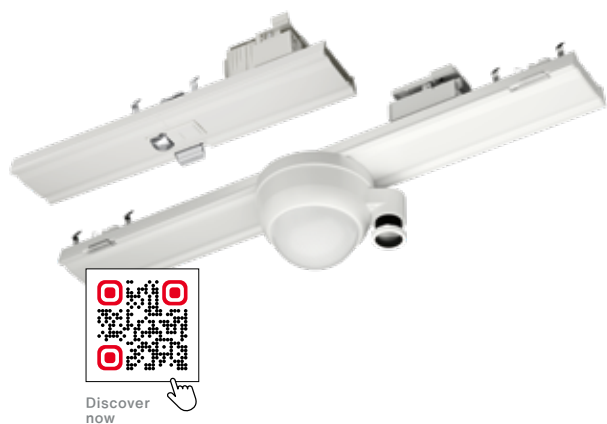

Demand-oriented lighting control: Sensors for Licross

- Secure detection of people and vehicles
- Installation heights up to 16 m
- Flexibility through modularity for changes in use
- Open, future-proof interfaces
- Standalone solution for simple refurbishment



Office lighting in the trunking system: Silica 21 for Licross

- Highly efficient office luminaire insert for optimum visual performance at the workplace
- Suitable for continuous row mounting with seamless louver optics



Discover now

For any atmosphere
Monsun 31 Tube for Licross

- Tubular luminaire insert for areas where harmful gases can be present, e.g. in tire warehouses
- Gas-tight with IP69 K
- Complies with the IFS (International Featured Standard) requirements for safety and quality in the food industry
- Wide range of applications thanks to high lumen packages



Discover now

Lighting for high halls:
Highbay 11 for Licross

- Highbay insert for high lumen packages of 16,000 or 32,000 lm
- Suitable for harsh environmental conditions thanks to IP64 and AT max. 45°C
- Complies with the IFS requirements for use in the food industry



Discover now

Accentuation and merchandise presentation:
Spot 31 for Licross

- Spot inserts for accent lighting and outstanding color rendering for attractive interior design or merchandise displays
- Available with different beam angles
- Adaptable to changing requirements thanks to interchangeable reflectors



Discover
now

Announcements, voice alarms and music from the trunking system:

Licross Connect Audio

- Stores, educational institutions and showrooms are usually spacious and require loudspeakers for announcements, music or voice alarms. SITECO Connect Audio turns Licross into a communication medium. That saves redundant electrical installations, because two free cores in the trunking system are simply used for audio transmission.

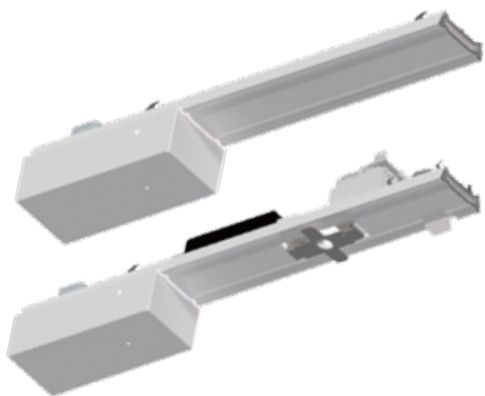

Discover
now

The Internet connection:

Licross Connect IP

- Data transmission with up to 1 Gbit/s up to a transmission length of over 300 m
- Network connection via the Licross LAN connector
- Universal interfaces (PoE adapters) are simply clicked into the mounting rail just like luminaire inserts, enabling cameras, WiFi routers or other IP devices to be operated
- Up to 12 ports / IP addresses at any position
- Saves additional installations, is easy to extend or retrofit, and ensures an uncluttered ceiling

Typical applications

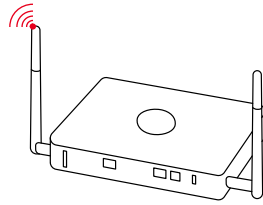

Internet access

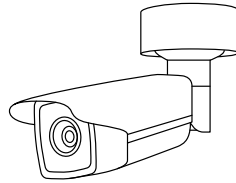

Video surveillance

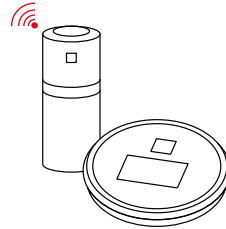

Tracking
(e.g. material flow monitoring)

The advantages at a glance

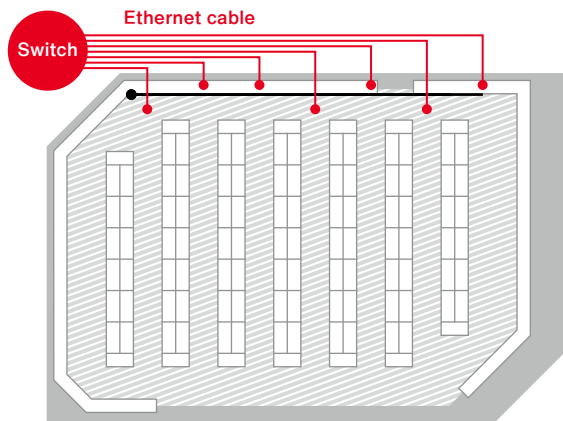

Previously complex installation:

- ⊖ Major installation effort
- ⊖ Only a maximum transmission length of 100 m
- ⊖ Low flexibility
- ⊖ High material expenditure
- ⊖ Large dimensioning of the network components
- ⊖ Visually mostly unsatisfactory

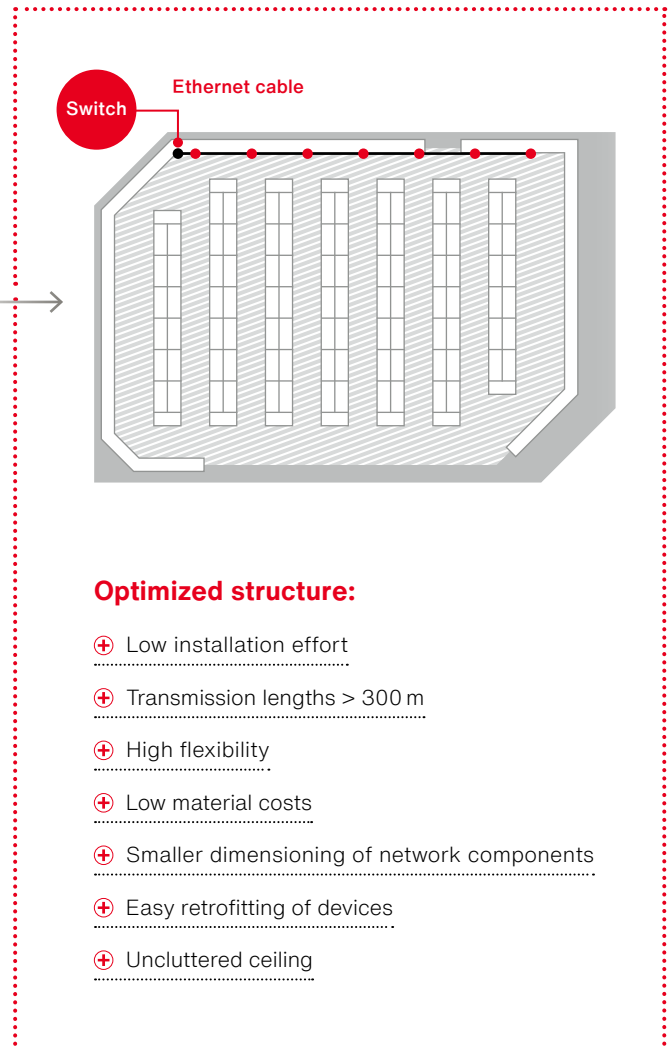

Optimized structure:

- ⊕ Low installation effort
- ⊕ Transmission lengths > 300 m
- ⊕ High flexibility
- ⊕ Low material costs
- ⊕ Smaller dimensioning of network components
- ⊕ Easy retrofitting of devices
- ⊕ Uncluttered ceiling

Full control.

Innovative control for even greater efficiency and faster amortization.

Lighting control pays off always and everywhere.

High energy prices make lighting control indispensable. It ensures reduced operating costs, an even faster amortization of the system, and is usually the prerequisite for a government subsidy.

Powerful sensors are essential for effective lighting control. Different areas of use require different sensors. For Licross, you will always find the right product, from the office to the highbay warehouse, and for every mounting height and all environmental requirements (IP20 to IP54) – easy to integrate with just one click.

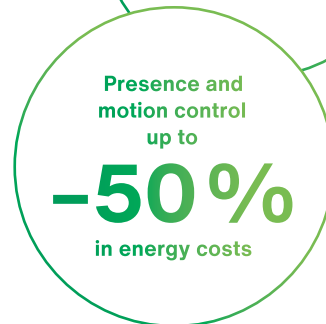
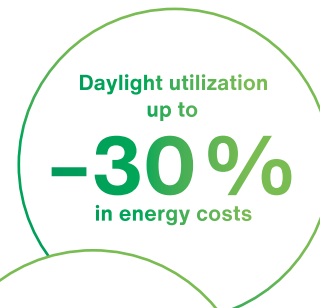

Local control

The uncomplicated solution for individual areas thanks to plug & play sensor technology – simple parameterization and commissioning by an electrical installer.



Central control

Full flexibility by connecting different lighting zones via central control and integration into the building management system.

Control across locations

Comprehensive networking and control of multiple locations for full transparency and intelligent analysis options.

Perfectly tailored solutions – from simple plug & play control to integrated building management systems.

NEW

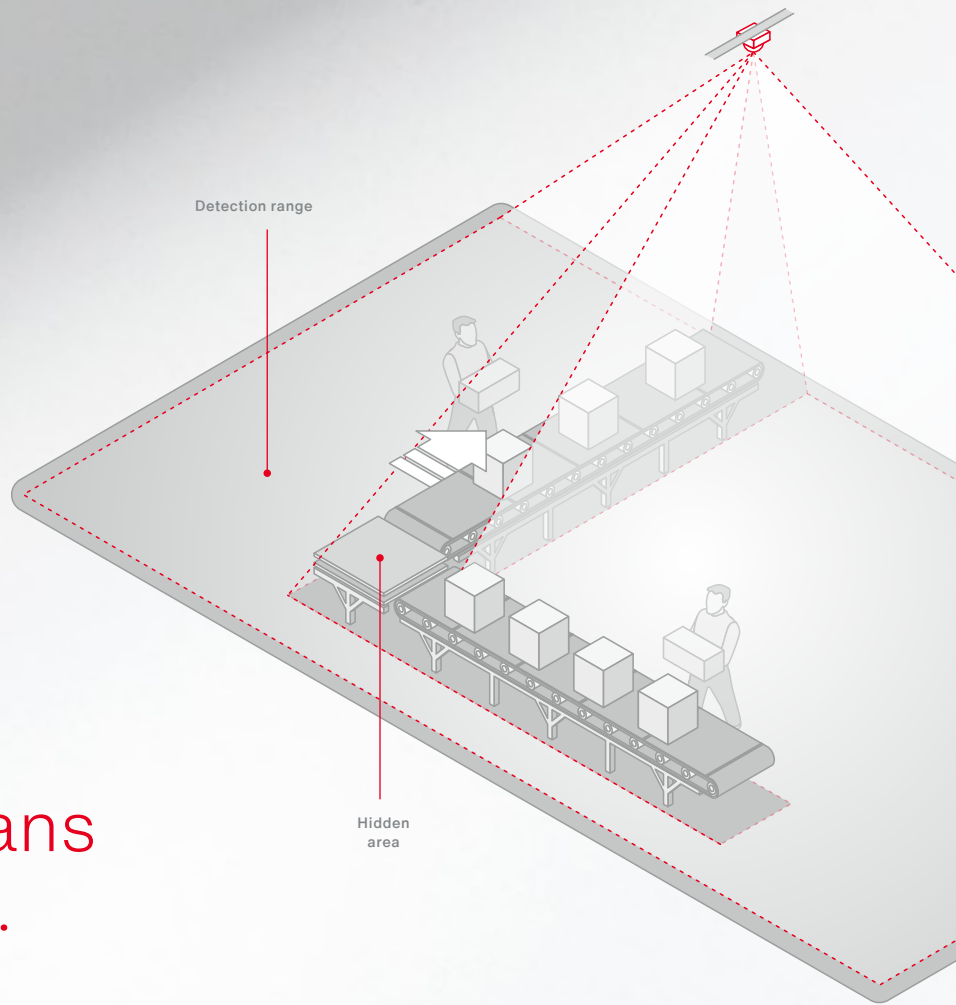

Sensors that distinguish between humans and machines.

Daylight and presence-dependent control saves a lot of energy. But what if the presence detector also switches on the light when machines move? SITECO has developed the Matrix Sensor for that purpose. This sensor of the future distinguishes between people and machines, and only switches on the light when it is really needed.

More flexible thanks to state-of-the-art electronics.

Luminaire inserts with **multilumen** can be used flexibly. If necessary, the luminous flux can be easily adjusted using a DIP switch, e.g. if the use of a room changes.

Constant luminous flux (CLOi) simplifies planning and saves energy. **DALI 2** gives you the full flexibility of lighting control.

Warehouse today, production tomorrow. With Licross, you remain flexible thanks to multilumen. If usage changes, you can easily adjust the illuminance levels using a DIP switch.

As in this case, for example, from 300 lx to 500 lx.

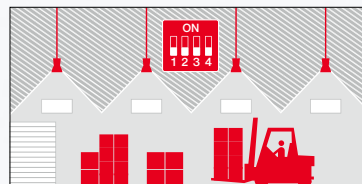

Warehouse with 300 lx



Production with 500 lx

Modario 31

> 180
lm/W

12
cores

The classic, now with up to 12 cores.



Now even more efficient.

With up to 180 lm/W, it's easy to tap into energy-saving potentials and implement the latest energy efficiency standards, whether for new systems or by replacing conventional inserts in existing Modario systems.

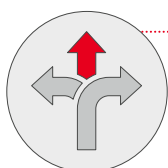

Now even more flexible.

Thanks to the extension to 12 cores and the new luminaire inserts **Modario 31 Silica**, **emergency light inserts** and **Monsun 31 for Modario**. Suitable for extensive applications such as storerooms and corridors, highbay racking, shipping areas or retail spaces.

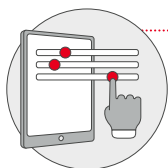

Everything under control.

Can be integrated into all modern light management systems thanks to DALI 2-variants.

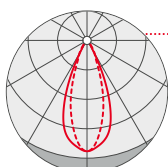

Always the right light.

Prismatic frosted optics for low glare and high visual comfort. Luminous flux tracking and multilumen capability also with ON / OFF versions provide the basis for lighting solutions tailored to your requirements.

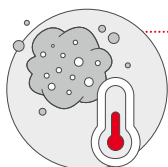

As robust as ever.

Service life of 70,000 h, protection ratings up to IP50 and temperature resistance up to 40 °C enable use even in demanding environments.

Flexible and expandable.

12 cores for more functions:

Modario 31 trunking system - the rail

- Flexible application thanks to 12 cores
- Linear through-wiring with fully variable tapping option for the inserts
- Available from 5-core to 12-core (2.5 mm²)
- Lengths: 4.5 m, 3 m or 1.5 m
- Tool-free mechanical and electrical connection of rails and inserts
- Protection rating: IP20
- Integration of various emergency lighting components in accordance with EN 60598-2-22



Discover
now



Now even more flexible.

Expandable by integrating
the latest inserts for lighting
and sensors.



Discover
now

Modario 31

Modario 31 Silica

Application	General lighting in halls, retail spaces, schools, ..	Lighting for offices and retail spaces / cashier areas
Distribution	extremely narrow / narrow / wide	medium / double. asym
Light colors K	4000 / 6500	4000
Glare control UGR	$\leq 25 / \leq 28$	$\leq 19 / \leq 22$
Luminous flux lm	7,600 to 12,400	max. 6,600
Luminous efficacy max. lm/W	> 180 lm/W	> 170 lm/W
Type of protection	IP20 / IP50	IP20
Ambient temp. max.	+40 °C	+40 °C
Service life	70,000h	70,000h

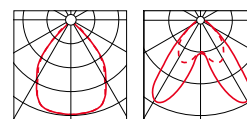
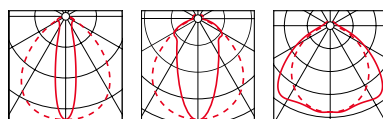



Demand-oriented lighting control: Sensors for Modario

- Safe detection of persons and vehicles
- Installation heights up to 14 m
- Flexibility through modularity for changes in use
- Open, future-proof interfaces
- Standalone solution for simple refurbishment



For any atmosphere Monsun 31 Tube for Modario

- Tubular luminaire insert for areas where harmful gases can be present, e.g. in tire warehouses
- Gas-tight with IP69 K
- Complies with the IFS (International Featured Standard) requirements for safety and quality in the food industry
- Wide range of applications thanks to high lumen packages

More flexible thanks to state-of-the-art electronics.

Luminaire inserts with **multilumen** can be used flexibly. If necessary, the luminous flux can be easily adjusted using a DIP switch, e.g. if the use of a room changes.

Constant luminous flux (CLOi) simplifies planning and saves energy.

DALI 2 gives you the full flexibility of lighting control.

Warehouse today, production tomorrow.

With Modario 31 you remain flexible thanks to multilumen. If usage changes, you can easily adjust the illuminance levels using a DIP switch.

As in this case, for example, from 300 lx to 500 lx

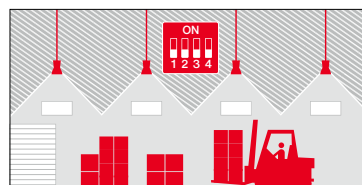

Warehouse with 300 lx

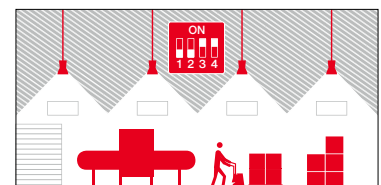

Production with 500 lx

DUS 31

> 180
lm/W

The refurbishment solution for the trunking pioneer.



Now even more efficient.

There is no more efficient and sustainable way to refurbish a conventional DUS lighting system. With up to 180 lm/W, you can easily increase your energy-saving potential and meet the latest energy efficiency standards.

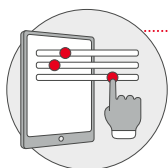

Everything under control.

Can be integrated into all modern light management systems thanks to DALI 2-variants.

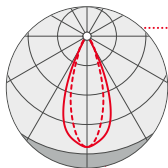

Always the right light.

Prismatic frosted optics for low glare and high visual comfort. Luminous flux tracking and multilumen capability also with ON / OFF versions provide the basis for lighting solutions tailored to your requirements.

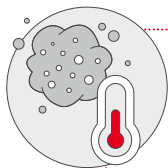

As robust as ever.

Service life of 70,000 h, protection ratings up to IP50 and temperature resistance up to 40°C enable use even in demanding environments.



DUS 31

Application	General lighting in halls, retail spaces, schools, ...
Distribution	narrow / wide
Light colors K	4000 / 6500
Glare control UGR	≤ 25 / ≤ 28
Luminous flux lm	7,600 to 12,400
Luminous efficacy max. lm/W	> 180 lm/W
Type of protection	IP20 / IP50
Ambient temp. max.	+40 °C
Service life	70,000h

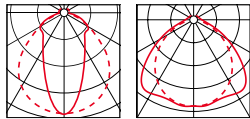

More flexible thanks to state-of-the-art electronics.

Luminaire inserts with **multilumen** can be used flexibly. If necessary, the luminous flux can be easily adjusted using a DIP switch, e.g. if the use of a room changes.

Constant luminous flux (CLOi) simplifies planning and saves energy.

DALI 2 gives you the full flexibility of lighting control.

Warehouse today, production tomorrow.

With DUS 31 you remain flexible thanks to multilumen. If usage changes, you can easily adjust the illuminance levels using a DIP switch. As in this case, for example, from 300 lx to 500 lx



Warehouse with 300 lx



Production with 500 lx

Trunking Flex 31

> 160
lm/W

For all
common
systems

The refurbishment insert for all trunking systems.



Economical and efficient.

With the Trunking Flex 31, all common trunking systems can be refurbished in a particularly sustainable way. With > 160 lm/W, you can easily increase your energy-saving potential and meet the latest energy efficiency standards.

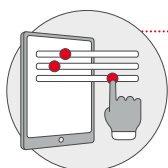

Everything under control.

Can be integrated into all modern light management systems thanks to DALI 2-variants.

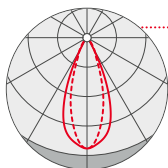

Always the right light.

The large selection of light distributions enables simple refurbishment of trunking systems for a wide range of applications. Multilumen capability also with ON / OFF versions provides the basis for lighting solutions tailored to your requirements.

More flexible thanks to state-of-the-art electronics.

Luminaire inserts with **multilumen** can be used flexibly. If necessary, the luminous flux can be easily adjusted using a DIP switch, e.g. if the use of a room changes.

DALI 2 gives you the full flexibility of lighting control.

Warehouse today, production tomorrow.

With Trunking Flex 31 you remain flexible thanks to multilumen. If usage changes, you can easily adjust the illuminance levels using a DIP switch. As in this case, for example, from 300 lx to 500 lx.

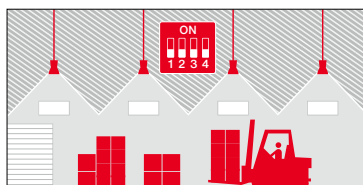

Warehouse with 300 lx

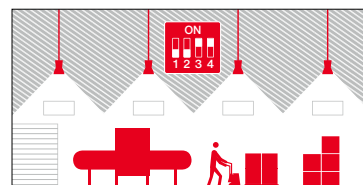

Production with 500 lx

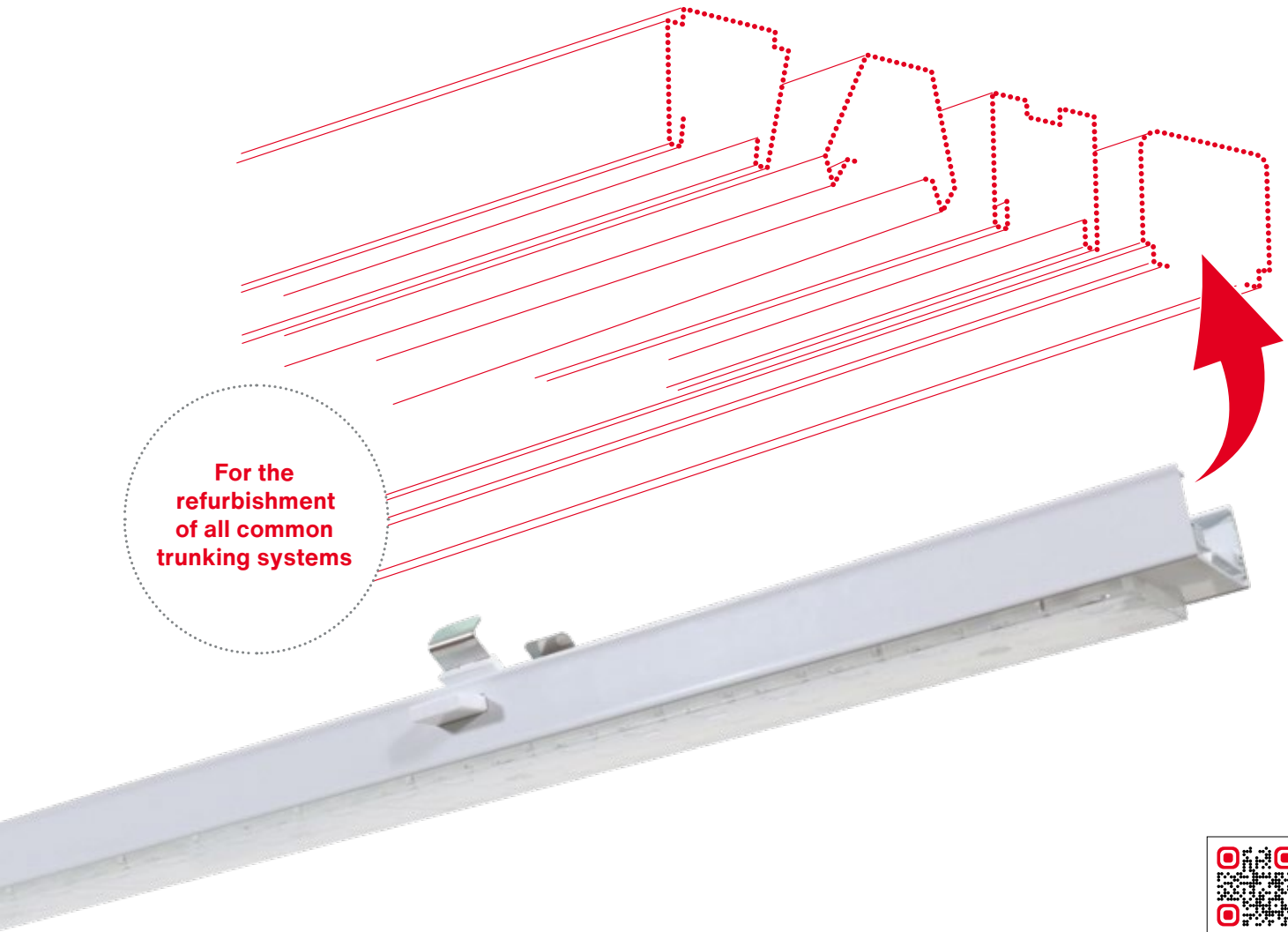

For the refurbishment of all common trunking systems



Trunking Flex 31*

Application	General lighting in halls, retail spaces, schools, ...
Distribution	narrow / medium / wide / asymmetrical / double asymmetrical
Light colors K	3500 / 4000 / 5000 / 6500
Glare control UGR	≤ 22 / ≤ 25 / ≤ 28
Luminous flux lm	6,400 to 11,500
Luminous efficacy max. lm/W	> 160 lm/W
Type of protection	IP20
Ambient temp. max.	+40 °C
Service life	50,000 h

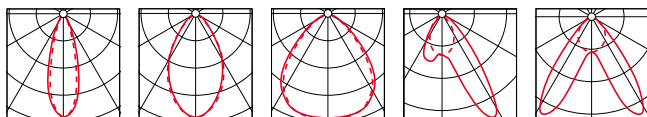

* optionally incl. through-wiring if existing wiring is not to be used

Sales.

Australia

SITECO UK Ltd
Hexagon Tower,
Crumpsall Vale, Blackley
Manchester, M9 8GQ
Phone +44 3300 555 209
contact-uk@siteco.com

Czech Republic

Siteco GmbH
contact-cz@siteco.com

Hungary

Siteco GmbH
contact-hu@siteco.com

Norway

SITECO Norway AS
Engebrets vei 5
0275 Oslo
Phone +47 45 37 71 00
kundesenter@siteco.com

Serbia

SITECO Serbia
Ivan Lazarevic
Dositejeva 1a
11 000 Belgrad
Phone: +381 69 5444 802
i.lazarevic@siteco.com

Sweden

SITECO Sweden AB
Källbäckstrydsgatan 3
507 42 Borås
Phone +46 8128 70 422
contact-se@siteco.com

Benelux

SITECO Benelux
Marten Meesweg 8-10
NL-3068 AV Rotterdam
Phone +31 85 4000 454
contact-nl@siteco.com

Finland

SITECO GmbH, Finnish Branch
Business Park Kehämylly
Vantaankoskentie 14
01670 VANTAA
contact-fi@siteco.com

Italy

SITECO Italy S.r.l.
Via Libero Temolo, 4
20126 Milan
Phone +39 320 0692561
contact-it@siteco.com

Poland

SITECO Poland Sp.z o.o.
Al. Jerozolimskie 94
00-807 Warszawa
Phone +48 22 462 49 30
contact-pl@siteco.pl

Slovakia

SITECO GmbH
Michael Bugar
Phone +421 904 266 999
contact-svk@siteco.com

United Kingdom

SITECO UK Ltd
Hexagon Tower,
Crumpsall Vale, Blackley
Manchester, M9 8GQ
Phone +44 3300 555 209
contact-uk@siteco.com

Bulgaria

SITECO Bulgaria
Andreea Luppa
Phone +40 735 316 760
a.luppa@siteco.eu

France

SITECO France Chez REGUS
7 rue Meyerbeen
75009 Paris
Phone +33 6 24 57 58 61
contact-fr@siteco.com

Moldova

SITECO Moldova
Andreea Luppa
Phone +40 735 316 760
a.luppa@siteco.eu

Portugal

SITECO Portugal
Cesar Campos
Phone +351 91 171 44 85
contact-pt@siteco.com

Slovenia

SITECO GmbH
Georg-Simon-Ohm-Straße 50
83301 Traunreut, Nemčija
Phone +386 51 373615
contact-si@siteco.si

Other Countries

SITECO GmbH
Georg-Simon-Ohm-Straße 50
83301 Traunreut, Germany
Phone +49 160 935 77095
contact-export@siteco.com

Croatia

SITECO Croatia
contact-hr@siteco.com

GCC Countries

SITECO UK Ltd
Hexagon Tower,
Crumpsall Vale, Blackley
Manchester, M9 8GQ
Phone +44 3300 555 209
contact-uk@siteco.com

New Zealand

SITECO UK Ltd
Hexagon Tower,
Crumpsall Vale, Blackley
Manchester, M9 8GQ
Phone +44 3300 555 209
contact-uk@siteco.com

Romania

SITECO Romania
Andreea Luppa
Phone: +40 735 316 760
a.luppa@siteco.eu

Spain

SITECO Lighting Spain, S.L.
Av. Leonardo da Vinci 15
28906 Madrid
Phone +34 9100 29095
contact-ES@siteco.com

Contact.

Siteco GmbH

Georg-Simon-Ohm-Str. 50
83301 Traunreut, Germany
Phone +49 8669 330
info@siteco.com

siteco.com